













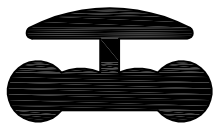

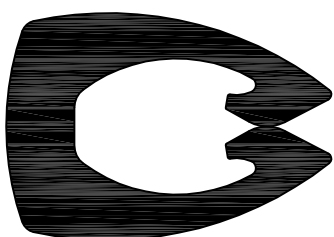











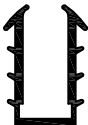



















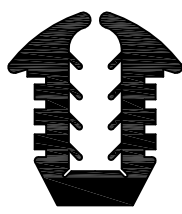
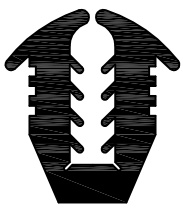





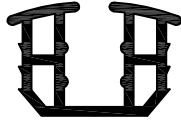
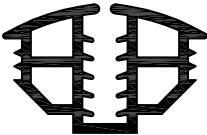

# CATÁLOGO GENERAL



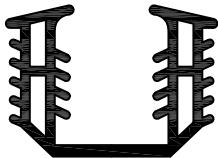

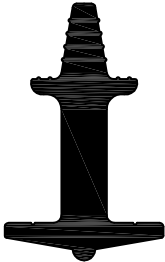

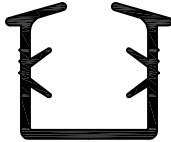





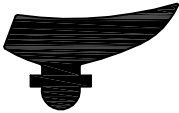

**EXTRUSIÓN DE PERFILES TÉCNICOS PLÁSTICOS**



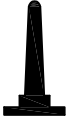



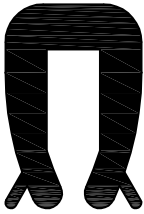





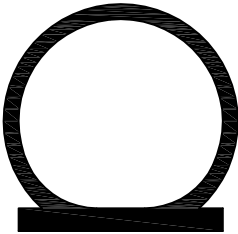

 <p>Ref.143 RG</p>	 <p>Ref. 144 RG</p>	 <p>Ref. 145 RG</p>
 <p>Ref. 207 FL</p>	 <p>Ref. 210 FL</p>	 <p>Ref. 211 FL</p>
 <p>Ref. 212 FL</p>	 <p>Ref. 329 FL</p>	 <p>Ref. 331 FL</p>
 <p>Ref. 337 FL</p>	 <p>Ref. 338 FL</p>	 <p>Ref. 339 FL</p>
 <p>Ref. 346 FL</p>	 <p>Ref. 351 FL</p>	 <p>Ref. 355 FL</p>

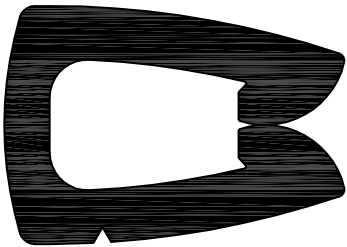
 Ref. 365 FL	 Ref. 368 FL	 Ref. 374 FL
 Ref. 375 FL	 Ref. 376 FL	 Ref. 378 FL
 Ref. 396 FL	 Ref. 397 FL	 Ref. 405 FL
 Ref. 410 FL	 Ref. 411 FL	 Ref. 413 FL
 Ref. 414 FL	 Ref. 415 FL	 Ref. 417 FL











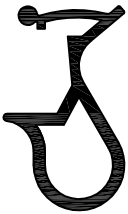



 Ref. 420 FL	 Ref. 421 FL	 Ref. 424 FL
 Ref. 426 FL	 Ref.427 FL	 Ref.437 FL
 Ref. 438 FL	 Ref. 447 FL	 Ref. 448 FL
 Ref. 456 FL	 Ref. 457 FL	 Ref. 459 FL
 Ref. 462 FL	 Ref. 465 FL	 Ref. 466 FL

		
Ref. 469 FL	Ref. 475 FL	Ref. 484 FL
		
Ref. 485 FL	Ref. 491 FL	Ref. 510 FL
		
Ref. 542 FL	Ref. 569 FL	Ref. 576 FL
		
Ref. 579 FL	Ref. 599 FL	Ref. 600 FL
		
Ref.674 FL	Ref.679 FL	Ref.684 FL















		
Ref. 698 FL	Ref. 700 FL	Ref. 725 FL
		
Ref. 726 FL	Ref. 730 FL	Ref. 741 FL
		
Ref. 758 FL	Ref. 766 FL	Ref. 784 FL
		
Ref. 785 FL	Ref. 793 FL	Ref. 796 FL
		
Ref. 799 FL	Ref. 804 FL	Ref. 806 FL





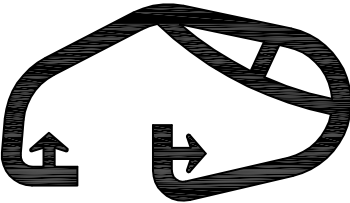

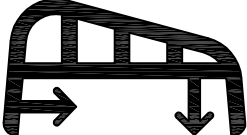

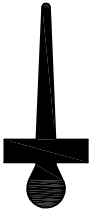
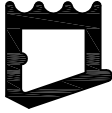
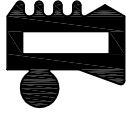
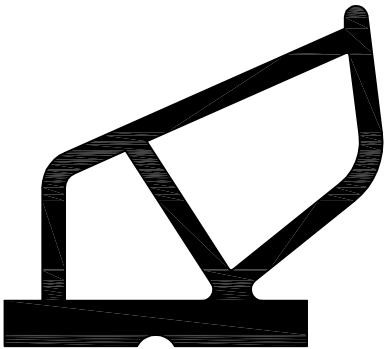

 Ref. 812 FL	 Ref. 817 FL	 Ref. 820 FL
 Ref. 821 FL	 Ref. 822 FL	 Ref. 835 FL
 Ref. 838 FL	 Ref. 840 FL	 Ref. 854 FL
 Ref. 855 FL	 Ref. 857 FL	 Ref. 859 FL
 Ref. 882 FL	 Ref. 891 FL	 Ref. 895 FL

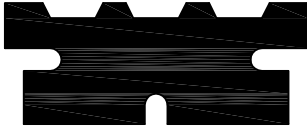















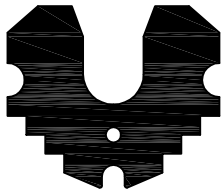













 Ref. 899 FL	 Ref. 900 FL	 Ref. 903 FL
 Ref. 916 FL	 Ref. 917 FL	 Ref. 925 FL
 Ref. 927 FL	 Ref. 938 FL	 Ref. 941 FL
 Ref. 949 FL	 Ref. 950 FL	 Ref. 972 FL
 Ref. 978 FL	 Ref. 992 FL	 Ref. 1056 FL

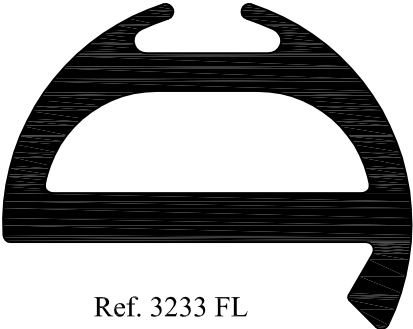



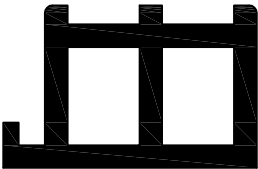













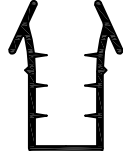



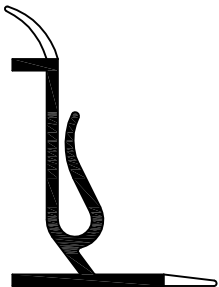









 <p>Ref. 1057 FL</p>	 <p>Ref. 1081 FL</p>	 <p>Ref. 3002 FL</p>
 <p>Ref. 3007 FL</p>	 <p>Ref. 3008 FL</p>	 <p>Ref. 3010 FL</p>
 <p>Ref. 3011 FL</p>	 <p>Ref. 3018 FL</p>	 <p>Ref. 3021 FL</p>
 <p>Ref. 3026 FL</p>	 <p>Ref. 3027 FL</p>	 <p>Ref. 3031 FL</p>
 <p>Ref. 3036 FL</p>	 <p>Ref. 3040 FL</p>	 <p>Ref. 3050 FL</p>

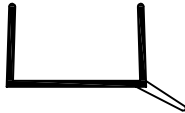









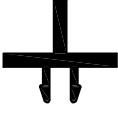
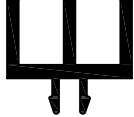
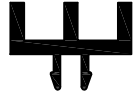

 <p>Ref. 3052 FL</p>	 <p>Ref. 3053 FL</p>	 <p>Ref. 3054 FL</p>
 <p>Ref. 3057 FL</p>	 <p>Ref. 3055 FL</p>	 <p>Ref. 3058 FL</p>
	 <p>Ref. 3059 FL</p>	 <p>Ref. 3086 FL</p>
 <p>Ref. 3087 FL</p>	 <p>Ref. 3101 FL</p>	 <p>Ref. 3111 FL</p>
 <p>Ref. 3117 FL</p>	 <p>Ref. 3118 FL</p>	 <p>Ref. 3123 FL</p>

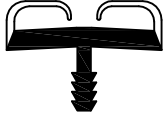

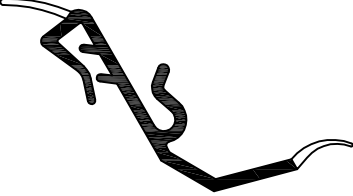



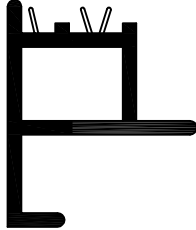







 <p>Ref. 3125 FL</p>	 <p>Ref. 3141 FL</p>	 <p>Ref. 3170 FL</p>
 <p>Ref. 3178 FL</p>	 <p>Ref. 3189 FL</p>	 <p>Ref. 3190 FL</p>
 <p>Ref. 3194 FL</p>	 <p>Ref. 3201 FL</p>	 <p>Ref. 3209 FL</p>
 <p>Ref. 3210 FL</p>	 <p>Ref. 3223 FL</p>	 <p>Ref. 3224 FL</p>
 <p>Ref. 3225 FL</p>	 <p>Ref. 3226 FL</p>	 <p>Ref. 3227 FL</p>

 <p>Ref. 3228 FL</p>	 <p>Ref. 3229 FL</p>	 <p>Ref. 3230 FL</p>
 <p>Ref. 3231 FL</p>	 <p>Ref. 3232 FL</p>	 <p>Ref. 3233 FL</p>
 <p>Ref. 3234 FL</p>	 <p>Ref. 3235 RG</p>	 <p>Ref. 3237 FL</p>
 <p>Ref. 3238 FL</p>	 <p>Ref. 3239 FL</p>	
 <p>Ref. 3240 FL</p>		 <p>Ref. 3241 FL</p>





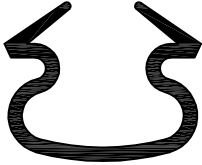







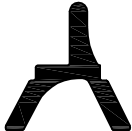

 <p>Ref. 3242 FL</p>	 <p>Ref. 3244 FL</p>	 <p>Ref. 3245 FL</p>
 <p>Ref. 3246 FL</p>	 <p>Ref. 3247 FL</p>	 <p>Ref. 3248 FL</p>
 <p>Ref. 3250 FL</p>	 <p>Ref. 3251 FL</p>	 <p>Ref. 3252 FL</p>
 <p>Ref. 3253 RG</p>	 <p>Ref. 3254 RG</p>	 <p>Ref. 3255 FL</p>
 <p>Ref. 3256 RG+FL</p>	 <p>Ref. 3259 FL</p>	 <p>Ref. 3260 FL</p>





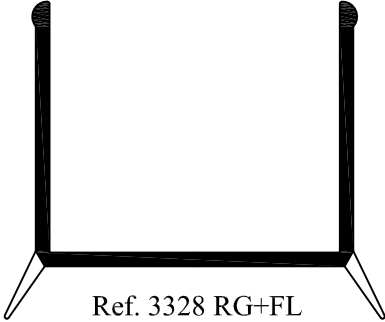

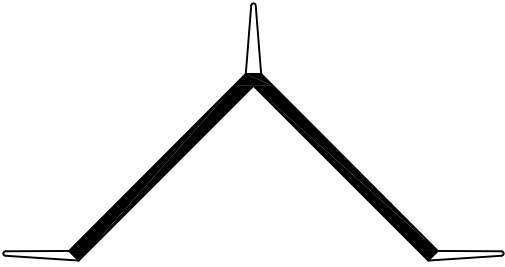

 Ref. 3261 FL	 Ref. 3262 FL	 Ref. 3263 FL
 Ref. 3264 FL	 Ref. 3265 FL	 Ref. 3266 FL
 Ref. 3267 FL	 Ref. 3268 RG+FL	 Ref. 3269 FL
 Ref. 3270 FL	 Ref. 3272 FL	 Ref. 3273 FL
 Ref. 3276 FL	 Ref. 3277 FL	 Ref. 3279 FL







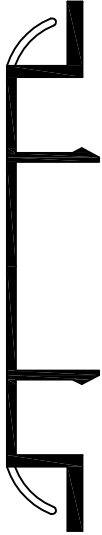
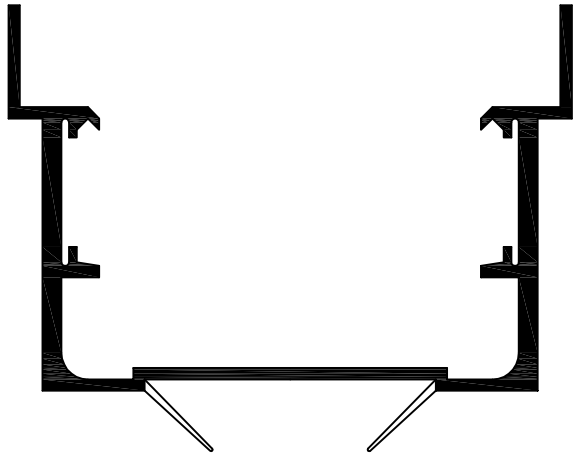

 <p>Ref. 3280 RG</p>	 <p>Ref. 3281 RG</p>	 <p>Ref. 3282 RG</p>
 <p>Ref. 3283 FL</p>	 <p>Ref. 3284 FL</p>	 <p>Ref. 3286 RG</p>
 <p>Ref. 3287 RG+FL</p>	 <p>Ref. 3288 RG+FL</p>	 <p>Ref. 3290 FL</p>
 <p>Ref. 3291 RG+FL</p>	 <p>Ref. 3292 FL</p>	 <p>Ref. 3293 FL</p>
 <p>Ref. 3294 FL</p>	 <p>Ref. 3295 RG+FL</p>	 <p>Ref. 3296 FL</p>

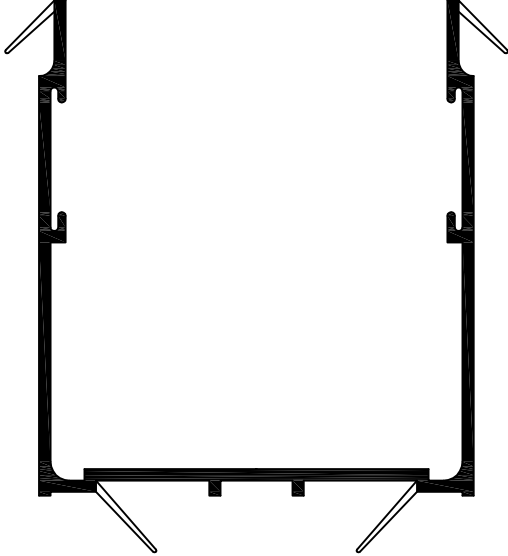
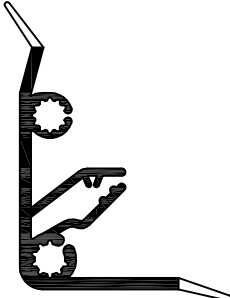

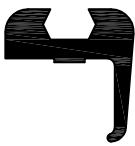



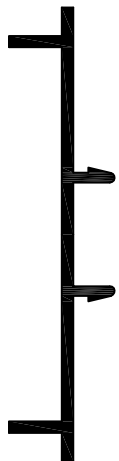



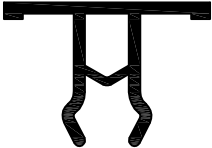

 <p>Ref. 3299 FL</p>	 <p>Ref. 3301 FL</p>	 <p>Ref. 3302 FL</p>
 <p>Ref. 3303 FL</p>	 <p>Ref. 3304 FL</p>	 <p>Ref. 3305 RG</p>
 <p>Ref. 3307 FL</p>	 <p>Ref. 3308 FL</p>	 <p>Ref. 3309 FL</p>
 <p>Ref. 3312 FL</p>	 <p>Ref. 3313 FL</p>	 <p>Ref. 3314 RG</p>
 <p>Ref. 3315 FL</p>	 <p>Ref. 3316 FL</p>	 <p>Ref. 3317 FL</p>

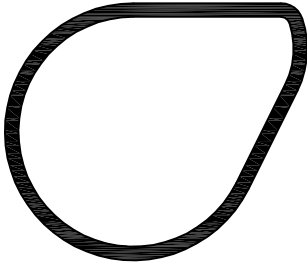



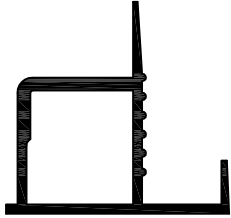
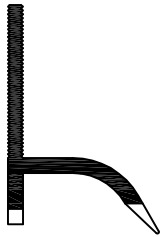



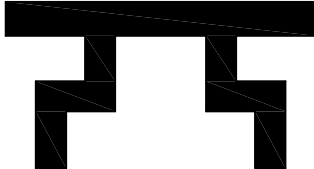





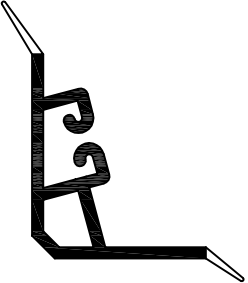
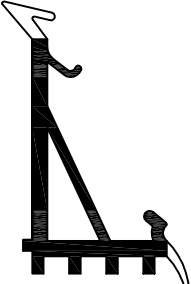

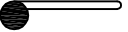

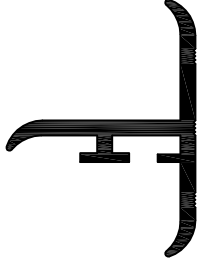



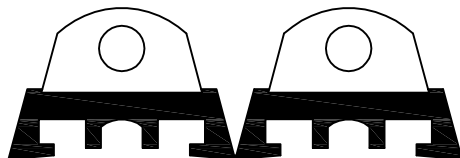
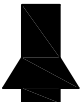

 Ref. 3318 FL	 Ref. 3319 FL	 Ref. 3320 FL
 Ref. 3321 FL	 Ref. 3322 RG	 Ref. 3323 FL
 Ref. 3324 FL	 Ref. 3325 FL	 Ref. 3326 FL
 Ref. 3327 RG	 Ref. 3328 RG+FL	 Ref. 3331 FL
 Ref. 3329 RG+FL		 Ref. 3332 FL

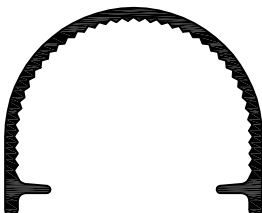









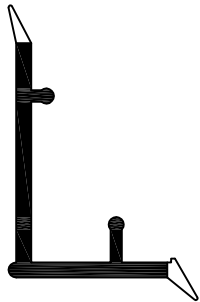
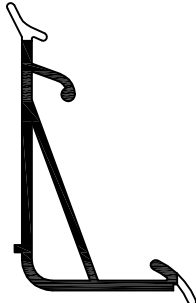

 <p>Ref. 3333 FL</p>	 <p>Ref. 3334 FL</p>	 <p>Ref. 3335 FL</p>
 <p>Ref. 3336 FL</p>	 <p>Ref. 3337 FL</p>	 <p>Ref. 3338 FL</p>
 <p>Ref. 3339 FL</p>	 <p>Ref. 3340 RG+FL</p>	 <p>Ref. 3341 RG+FL</p>
 <p>Ref. 3342 RG+FL</p>		

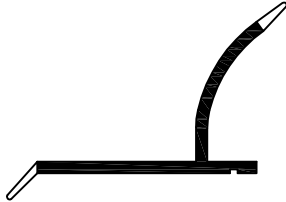



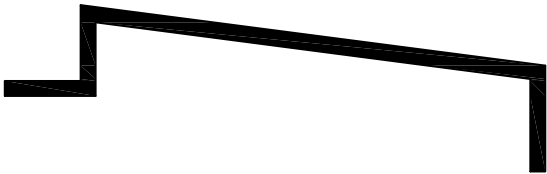

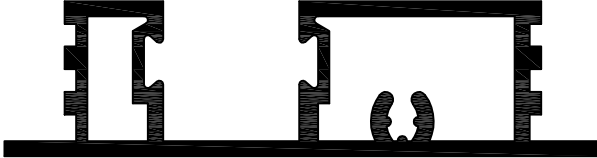

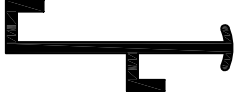

 <p>Ref. 3343 RG+FL</p>		 <p>Ref. 3346 RG+FL</p>
		 <p>Ref. 3347 FL</p>
 <p>Ref. 3348 FL</p>	 <p>Ref. 3349 FL</p>	 <p>Ref. 3350 RG</p>
 <p>Ref. 3351 RG</p>	 <p>Ref. 3352 RG</p>	 <p>Ref. 3353 RG</p>
 <p>Ref. 3355 FL</p>	 <p>Ref. 3356 FL</p>	

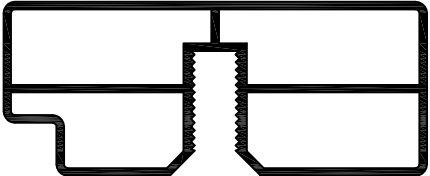
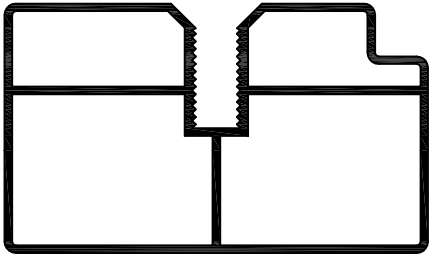
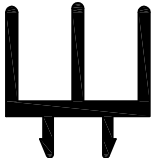
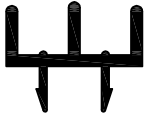
 <p>Ref. 3357 FL</p>	 <p>Ref. 3358 FL</p>	 <p>Ref. 3359 RG</p>
 <p>Ref. 3360 FL</p>	 <p>Ref. 3362 RG</p>	 <p>Ref. 3363 FL</p>
 <p>Ref. 3365 RG</p>	 <p>Ref. 3366 RG</p>	 <p>Ref. 3367 RG</p>
 <p>Ref. 3368 RG+FL</p>	 <p>Ref. 3369 RG</p>	 <p>Ref. 3370 FL</p>
 <p>Ref. 3371 RG+FL</p>	 <p>Ref. 3372 FL</p>	 <p>Ref. 3373 RG</p>











 Ref. 3376 FL+FL	 Ref. 3378 RG	 Ref. 3377 RG+FL
 Ref. 3379 FL	 Ref. 3380 FL	
 Ref. 3381 RG+FL	 Ref. 3382 RG+FL	 Ref. 3385 RG
 Ref. 3387 RG+FL	 Ref. 3389 FL	 Ref. 3390 FL
 Ref. 3391 FL	 Ref. 3392 RG+FL	 Ref. 3393 FL

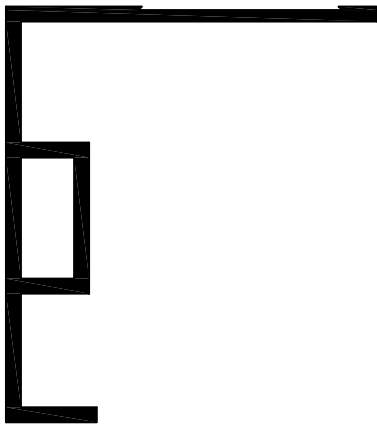

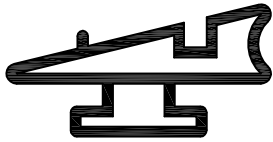



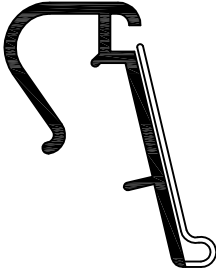
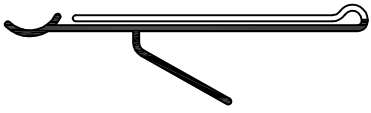

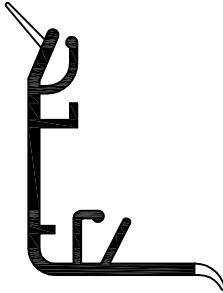

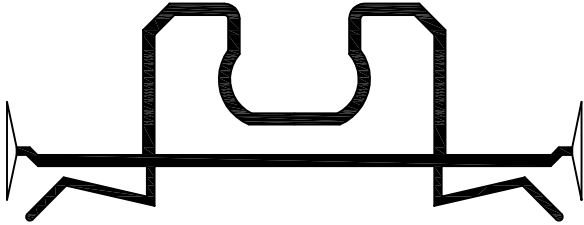
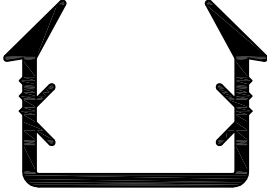
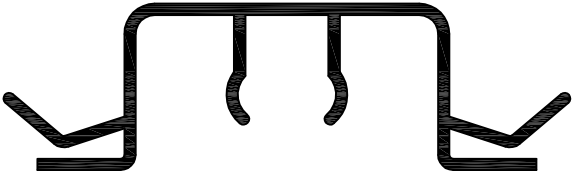
 Ref. 3396 FL	 Ref. 3395 FL+FL	
 Ref. 3397 FL	 Ref. 3398 FL	 Ref. 3399 RG
 Ref. 3400 FL	 Ref. 3401 RG+FL	 Ref. 3402 FL
 Ref. 3403 FL	 Ref. 3405 RG	 Ref. 3408 RG+FL
 Ref. 3404 FL		 Ref. 3410 RG+FL

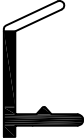









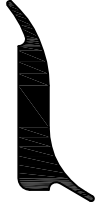

 <p>Ref. 3411 FL</p>	 <p>Ref. 3412 FL</p>	 <p>Ref. 3413 RG+FL</p>
 <p>Ref. 3414 RG+FL</p>	 <p>Ref. 3415 RG+FL</p>	 <p>Ref. 3416 RG+FL</p>
 <p>Ref. 3417 FL</p>	 <p>Ref. 3418 FL</p>	 <p>Ref. 3424 FL</p>
 <p>Ref. 3420 RG</p>	 <p>Ref. 3425 FL</p>	
 <p>Ref. 3421 RG</p>	 <p>Ref. 3426 FL</p>	

 <p>Ref. 3429 FL</p>	 <p>Ref. 3430 RG</p>	 <p>Ref. 3431 RG</p>
 <p>Ref. 3434 RG</p>	 <p>Ref. 3435 RG</p>	
 <p>Ref. 3436 RG</p>	 <p>Ref. 3437 RG</p>	 <p>Ref. 3439 RG</p>
 <p>Ref. 3440 FL</p>	 <p>Ref. 3441 FL</p>	 <p>Ref. 3442 FL</p>
 <p>Ref. 3443 FL</p>	 <p>Ref. 3444 FL</p>	 <p>Ref. 3445 FL</p>



 <p>Ref. 3447 FL</p>	 <p>Ref. 3448 RG+RG</p>	 <p>Ref. 3449 FL</p>
 <p>Ref. 3446 RG</p>	 <p>Ref. 3450 FL</p>	 <p>Ref. 3453 FL</p>
	 <p>Ref. 3454 RG+FL</p>	 <p>Ref. 3455 FL</p>
 <p>Ref. 3456 RG</p>	 <p>Ref. 3458 RG+RG</p>	 <p>Ref. 3460 RG+RG</p>
 <p>Ref. 3462 RG</p>	 <p>Ref. 3468 FL</p>	 <p>Ref. 3471 RG+FL</p>

 <p>Ref. 3469 RG+FL</p>		 <p>Ref. 3472 FL</p>
 <p>Ref. 3470 RG</p>		 <p>Ref. 3473 RG+FL</p>
 <p>Ref. 3474 RG+FL</p>	 <p>Ref. 3475 FL</p>	 <p>Ref. 3477 FL</p>
 <p>Ref. 3476 RG</p>		 <p>Ref. 3478 RG</p>
 <p>Ref. 3479 RG</p>	 <p>Ref. 3482 FL</p>	 <p>Ref. 3483 FL</p>

 <p>Ref. 3484 FL</p>	 <p>Ref. 3486 RG</p>	 <p>Ref. 3487 RG</p>
 <p>Ref. 3488 FL</p>	 <p>Ref. 3489 FL</p>	 <p>Ref. 3490 FL</p>
 <p>Ref. 3491 RG</p>		 <p>Ref. 3493 RG+FL</p>
 <p>Ref. 3492 RG</p>		 <p>Ref. 3494 FL</p>
 <p>Ref. 3492-L RG</p>		 <p>Ref. 3496 RG+FL</p>



Ref. 3498 RG

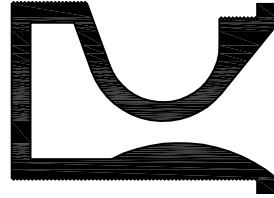

Ref. 3499 FL



Ref. 3501 RG



Ref. 3500 RG



Ref. 3502 FL



Ref. 3503 RG+FL

a



Ref. 3504 FL

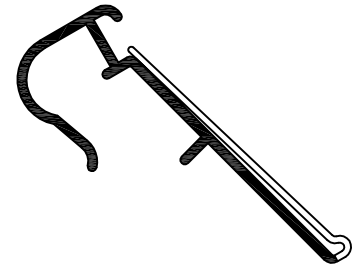

Ref. 3506 RG+RG

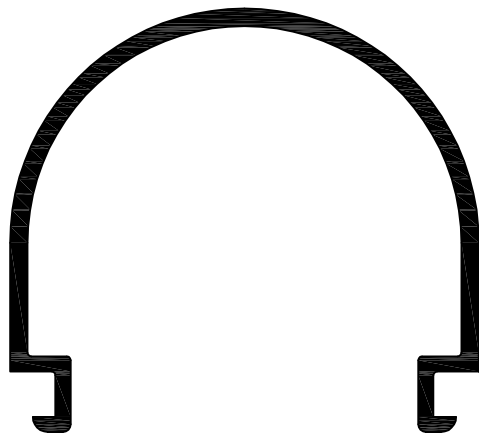



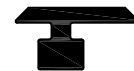









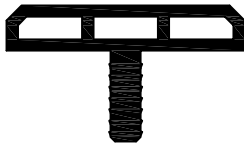

Ref. 3505 RG



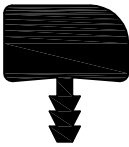

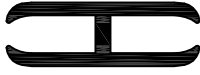









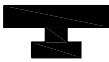
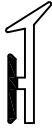

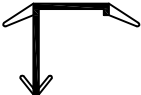

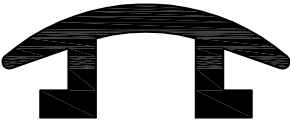





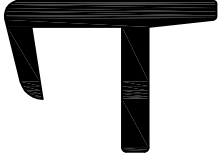

Ref. 3507 RG



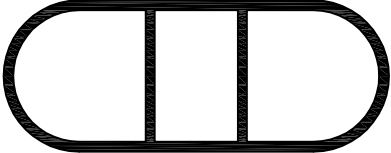
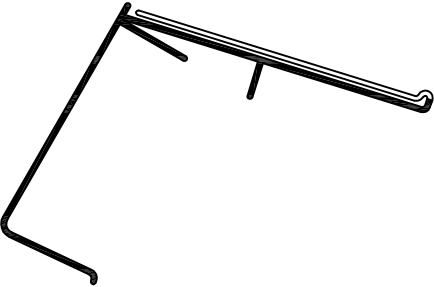
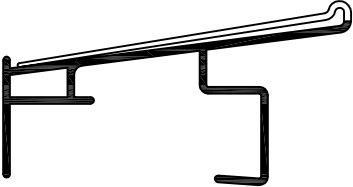





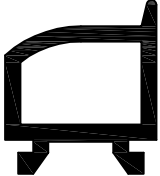



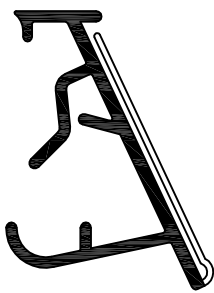

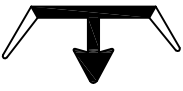
Ref. 3509 RG+FL

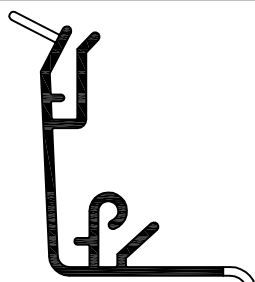

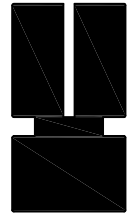

 <p>Ref. 3510 FL</p>	 <p>Ref. 3511 FL</p>	 <p>Ref. 3513 FL</p>
 <p>Ref. 3512 RG</p>		 <p>Ref. 3514 RG</p>
 <p>Ref. 3515 FL</p>	 <p>Ref. 3517 FL</p>	 <p>Ref. 3518 RG+FL</p>
 <p>Ref. 3519 RG</p>	 <p>Ref. 3520 RG</p>	 <p>Ref. 3521 RG</p>
 <p>Ref. 3522 FL</p>	 <p>Ref. 3523 RG</p>	 <p>Ref. 3525 RG</p>

 <p>Ref. 3526 FL</p>	 <p>Ref. 3527 FL</p>	 <p>Ref. 3528 RG</p>
 <p>Ref. 3529 RG</p>	 <p>Ref. 3530 FL</p>	 <p>Ref. 3531 RG+FL</p>
 <p>Ref. 3532 RG+FL</p>	 <p>Ref. 3533 RG+FL</p>	 <p>Ref. 3535 FL</p>
 <p>Ref. 3536 FL</p>	 <p>Ref. 3539 RG</p>	 <p>Ref. 3540 RG+FL</p>
 <p>Ref. 3541 RG</p>		 <p>Ref. 3542 FL</p>

 <p>Ref. 3543 FL</p>	 <p>Ref. 3544 FL</p>	 <p>Ref. 3545 FL</p>
 <p>Ref. 3547 FL</p>	 <p>Ref. 3548 FL</p>	 <p>Ref. 3549 FL</p>
 <p>Ref. 3550 RG+RG</p>	 <p>Ref. 3551 RG+RG</p>	 <p>Ref. 3552 FL</p>
 <p>Ref. 3553 RG+FL</p>	 <p>Ref. 3554 FL</p>	 <p>Ref. 3555 FL</p>
 <p>Ref. 3556 RG</p>	 <p>Ref. 3557 FL</p>	 <p>Ref. 3560 FL</p>

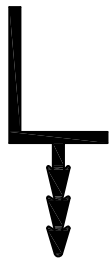
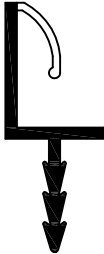
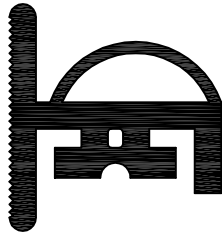
 Ref. 3559 FL		 Ref. 3561 RG
 Ref. 3562 RG	 Ref. 3564 RG+RG	 Ref. 3565 RG+FL
 Ref. 3566 RG+FL	 Ref. 3567 RG+FL	 Ref. 3568 FL
 Ref. 3569 RG+FL	 Ref. 3570 RG+FL	 Ref. 3571 FL
 Ref. 3572 RG+FL	 Ref. 3573 RG	 Ref. 3575 RG+FL

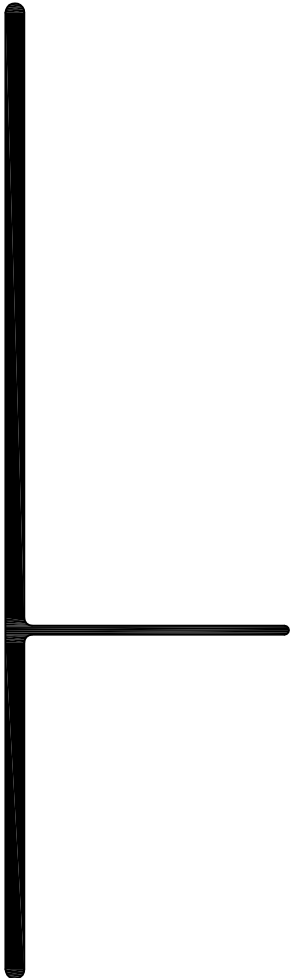
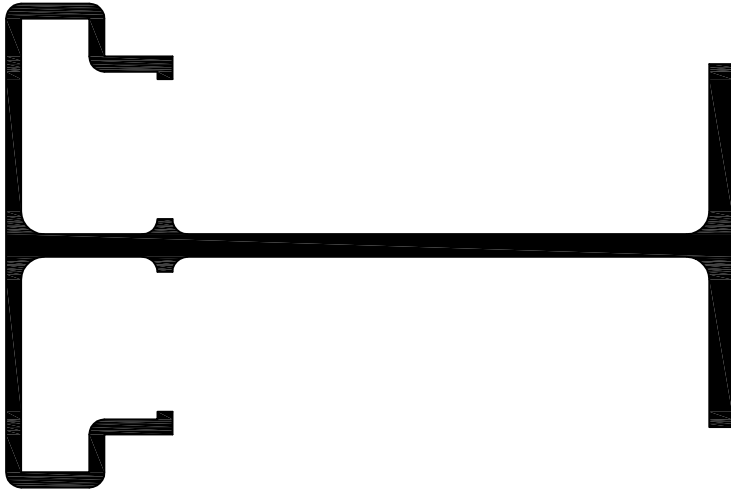
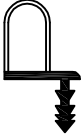
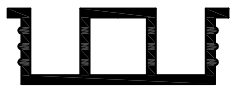

 <p>Ref. 3576 s/a RG</p>	 <p>Ref. 3576 RG+FL</p>	 <p>Ref. 3577 FL</p>
 <p>Ref. 3578 RG</p>	 <p>Ref. 3579 RG+FL</p>	 <p>Ref. 3580 RG+FL</p>
 <p>Ref. 3582 RG</p>	 <p>Ref. 3583 RG</p>	
	 <p>Ref. 3581 RG+FL</p>	 <p>Ref. 3584 RG</p>

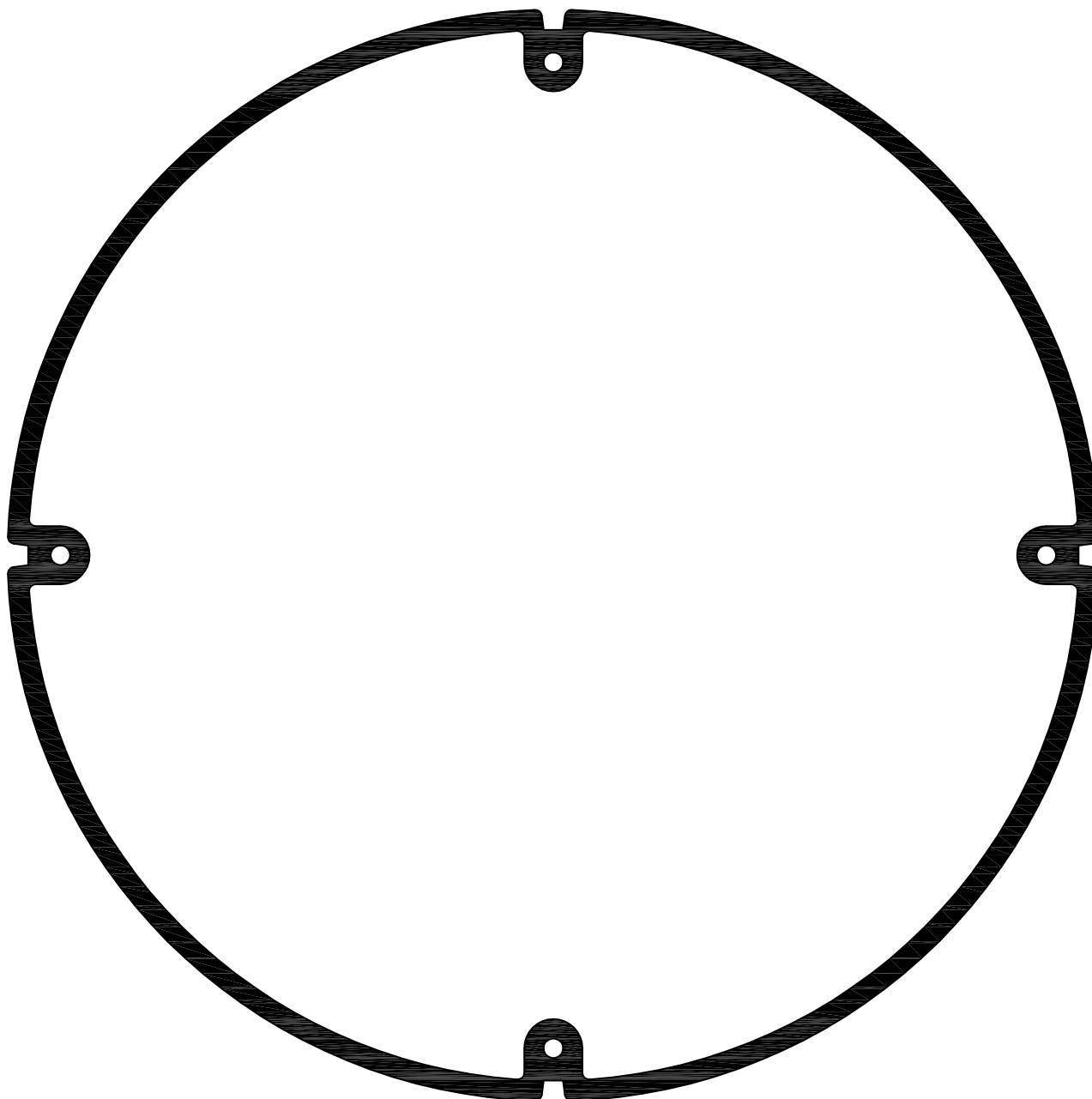

Ref. 3585 RG











Ref. 3586 FL

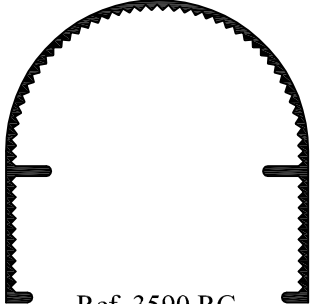

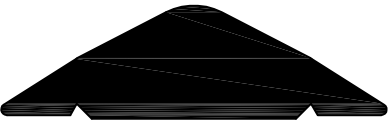

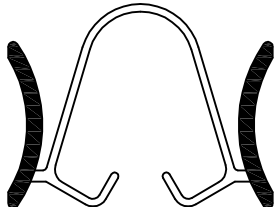
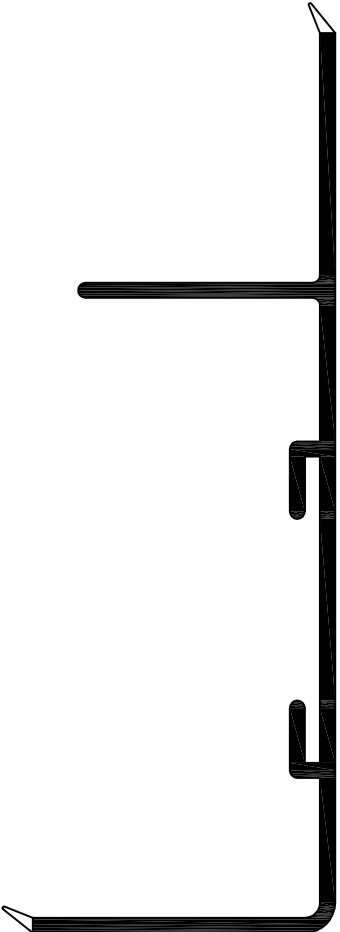
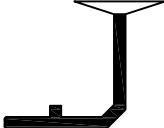





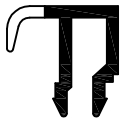
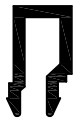







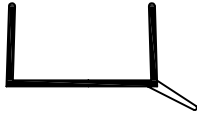





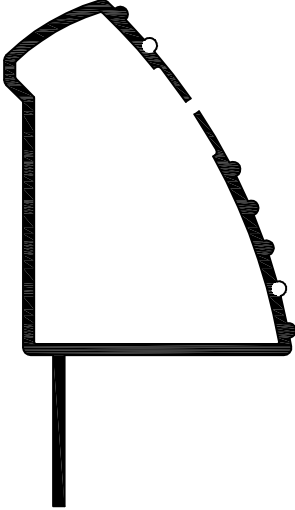

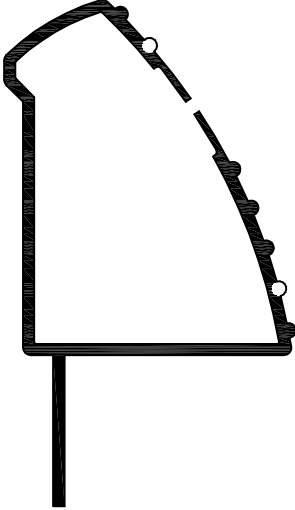
Ref. 3587 FL

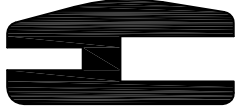
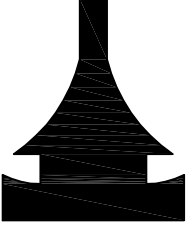

Ref. 3588 FL

 <p>Ref. 3589 FL</p>	 <p>Ref. 3590 RG</p>	 <p>Ref. 3591 FL</p>
 <p>Ref. 3592 FL</p>	 <p>Ref. 3593 RG</p>	 <p>Ref. 3594 RG+FL</p>
 <p>Ref. 3595 RG+FL</p>	 <p>Ref. 3596 RG+FL</p>	 <p>Ref. 3597 RG+FL</p>
	 <p>Ref. 3598 RG</p>	 <p>Ref. 3599 RG</p>
	 <p>Ref. 3600 RG</p>	

 Ref. 3602 RG+FL	 Ref. 3603 RG	 Ref. 3604 FL
 Ref. 3606 RG	 Ref. 3607 RG+FL	 Ref. 3608 RG+FL
 Ref. 3609 RG	 Ref. 3612 RG	 Ref. 3613 FL
 Ref. 3614 FL	 Ref. 3615 RG+FL	 Ref. 3616 FL
 Ref. 3617 RG	 Ref. 3618 RG	 Ref. 3620 FL

 Ref. 3621 RG	 Ref. 3621 RG	 Ref. 3624 RG+FL
 Ref. 3621 RG	 Ref. 3625 FL	 Ref. 3626 FL
 Ref. 3628 FL	 Ref. 3629 FL	 Ref. 3631 RG+FL
 Ref. 3632 FL	 Ref. 3633 RG+FL	 Ref. 3635 FL
 Ref. 3636 FL	 Ref. 3637 RG	 Ref. 3638 FL

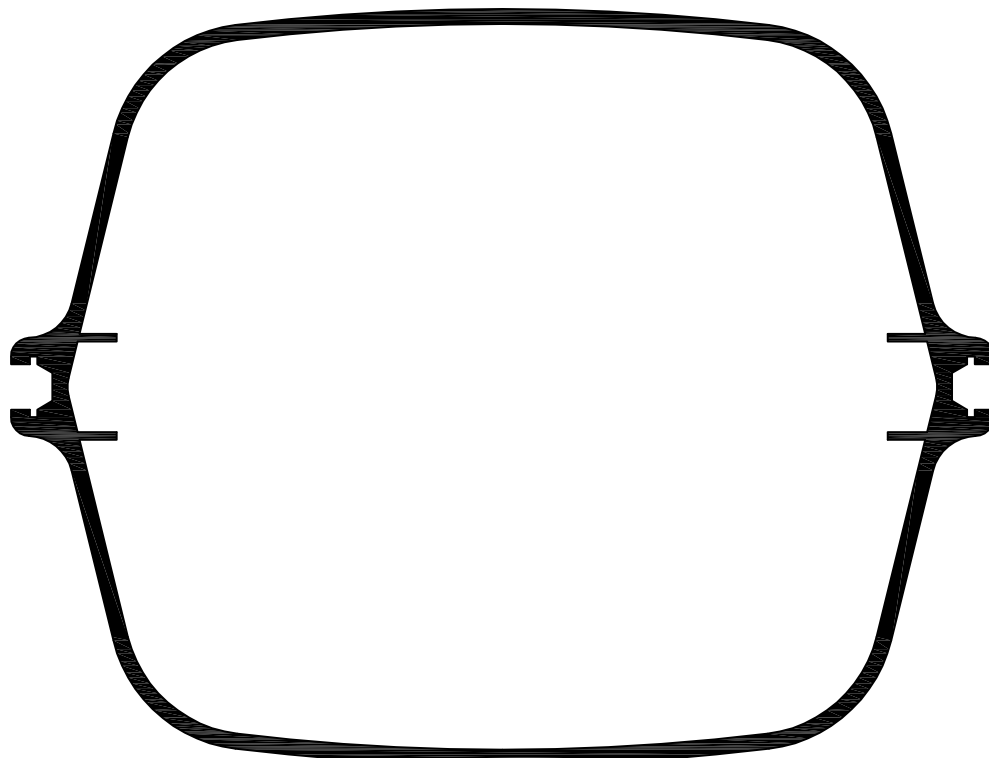

Ref. 3640 RG

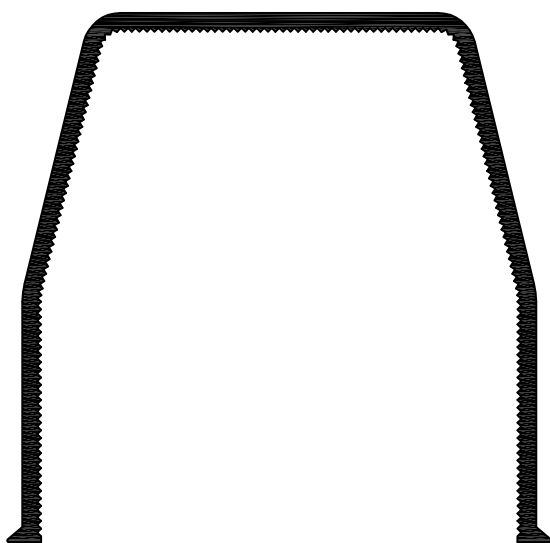











Ref. 3644 RG

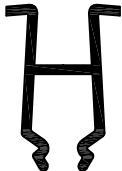









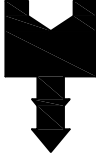
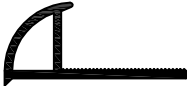
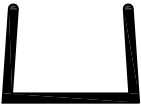

Ref. 3641 RG+FL























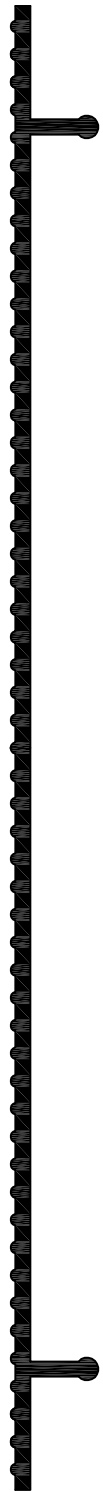

Ref. 3642 RG



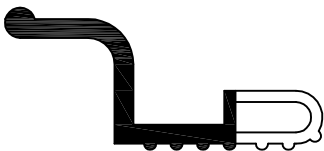





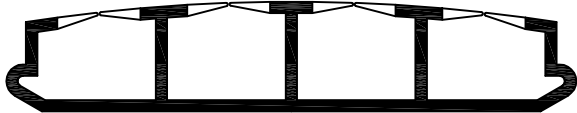

	 Ref. 3643 FL	 Ref. 3645 FL
	 Ref. 3648 RG	 Ref. 3649 EPDM
	 Ref. 3650 FL	 Ref. 3651 RG
	 Ref. 3653 FL	 Ref. 3654 FL
	 Ref. 3655 FL	 Ref. 3656 RG
	Ref. 3646 FL	

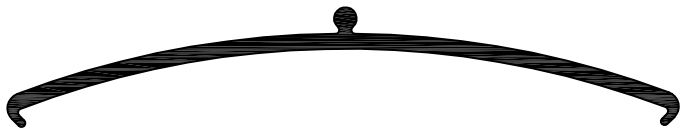





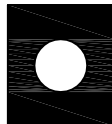
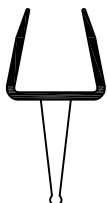

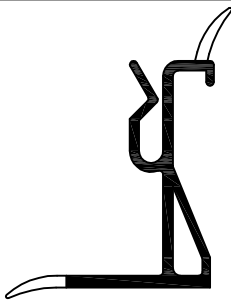

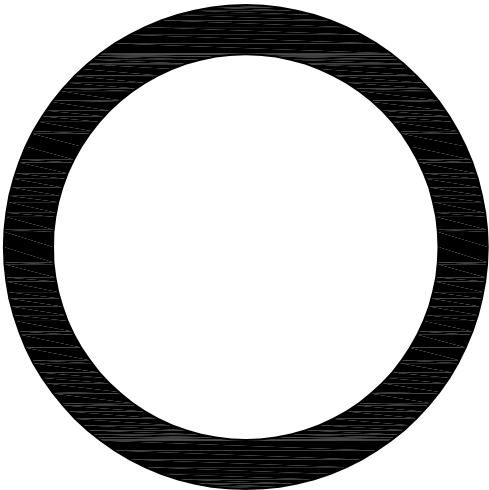

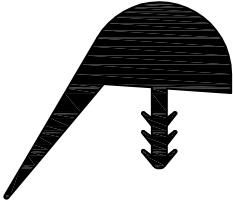
 <p>Ref. 3657 RG</p>		 <p>Ref. 3658 EPDM</p>
 <p>Ref. 3659 RG</p>	 <p>Ref. 3663 FL</p>	 <p>Ref. 3665 EPDM</p>
 <p>Ref. 3667 EPDM</p>	 <p>Ref. 3668 EPDM</p>	 <p>Ref. 3669 RG</p>
 <p>Ref. 3670 FL</p>	 <p>Ref. 3671 RG</p>	 <p>Ref. 3672 RG</p>
 <p>Ref. 3673 RG</p>	 <p>Ref. 3675 FL</p>	 <p>Ref. 3677 EPDM</p>



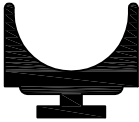

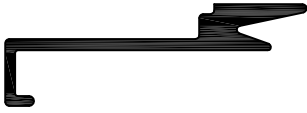





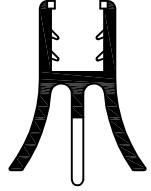







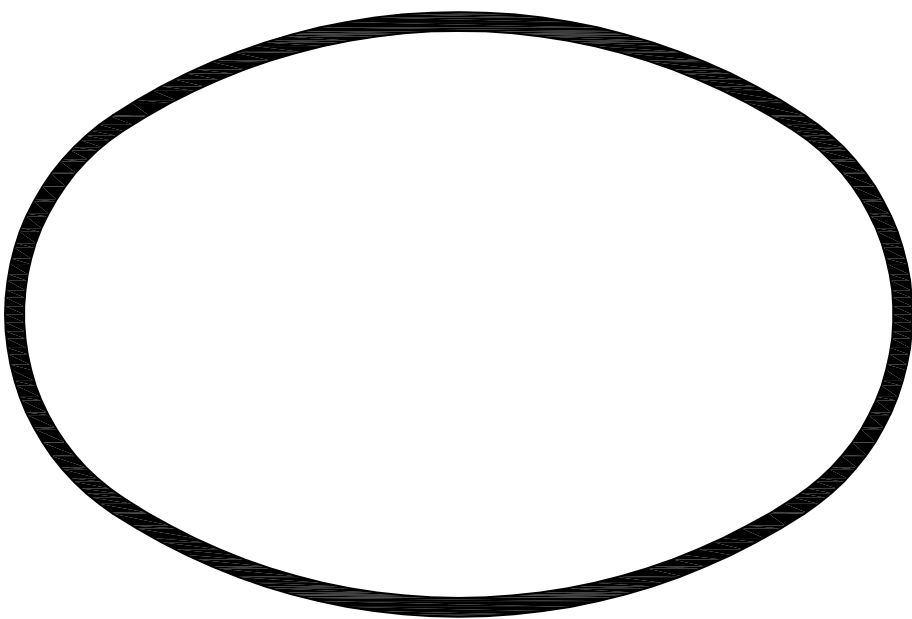

		
Ref. 3676 RG		Ref. 3678 RG
		
Ref. 3679 RG	Ref. 3681 RG	
		
Ref. 3682 RG		
		
Ref. 3684 RG+FL	Ref. 3685 RG	Ref. 3686 RG+FL
		
Ref. 3687 RG	Ref. 3688 RG	Ref. 3690 FL

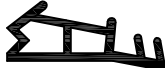

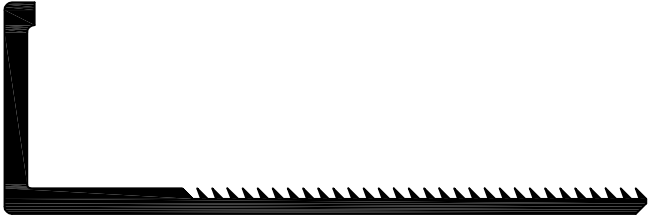
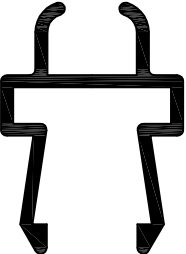
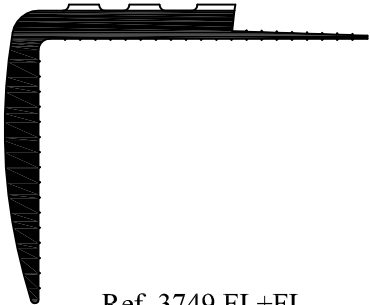
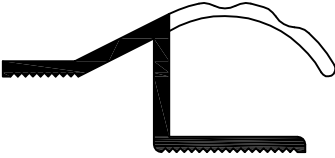
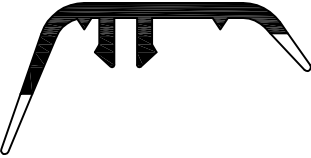











	 Ref. 3691 FL	 Ref. 3692 RG+FL
	 Ref. 3693 RG+FL	 Ref. 3695 RG+FL
	 Ref. 3696 EPDM	 Ref. 3697 EPDM
	 Ref. 3698 EPDM	 Ref. 3699 EPDM
	 Ref. 3700 EPDM	 Ref. 3704 EPDM
	Ref. 3694 RG	













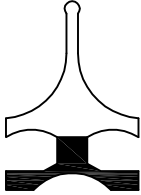

 <p>Ref. 3702 RG+FL</p>		 <p>Ref. 3705 EPDM</p>
 <p>Ref. 3703 RG</p>		 <p>Ref. 3706 EPDM</p>
 <p>Ref. 3707 EPDM</p>	 <p>Ref. 3708 EPDM</p>	 <p>Ref. 3709 EPDM</p>
 <p>Ref. 3710 EPDM</p>	 <p>Ref. 3711 EPDM</p>	 <p>Ref. 3712 FL</p>
 <p>Ref. 3714 RG+FL</p>	 <p>Ref. 3715 FL</p>	 <p>Ref. 3716 RG+FL</p>

 <p>Ref. 3713 EPDM</p>		 <p>Ref. 3717 EPDM</p>
		 <p>Ref. 3720 FL</p>
 <p>Ref. 3721 EPDM</p>	 <p>Ref. 3722 RG+FL</p>	 <p>Ref. 3723 FL</p>
 <p>Ref. 3724 FL</p>	 <p>Ref. 3725 RG</p>	 <p>Ref. 3726 RG</p>
 <p>Ref. 3727 RG</p>	 <p>Ref. 3729 EPDM</p>	 <p>Ref. 3730 EPDM</p>

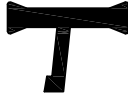



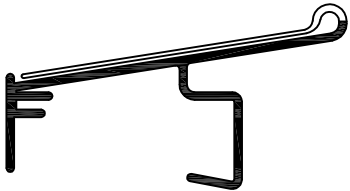

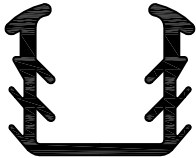





 <p>Ref. 3731 RG</p>	 <p>Ref. 3732 RG+FL</p>	 <p>Ref. 3733 FL</p>
 <p>Ref. 3734 FL</p>	 <p>Ref. 3736 RG+FL</p>	 <p>Ref. 3737 RG+FL</p>
 <p>Ref. 3738 FL</p>	 <p>Ref. 3739 RG+FL</p>	 <p>Ref. 3740 FL</p>
 <p>Ref. 3741 RG</p>		



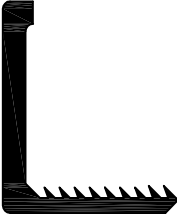
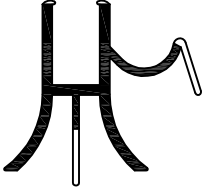



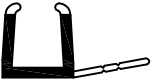





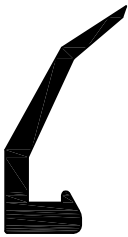

 <p>Ref. 3742 EPDM</p>	 <p>Ref. 3743 FL</p>	 <p>Ref. 3744 EPDM</p>
 <p>Ref. 3745 FL</p>	 <p>Ref. 3746 RG</p>	
 <p>Ref. 3747 RG</p>	 <p>Ref. 3749 FL+FL</p>	 <p>Ref. 3750 RG+FL</p>
 <p>Ref. 3751 RG+FL</p>	 <p>Ref. 3753 RG+FL</p>	 <p>Ref. 3754 EPDM</p>
 <p>Ref. 3755 EPDM</p>	 <p>Ref. 3756 RG+FL</p>	 <p>Ref. 3757 EPDM</p>













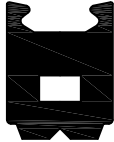

 Ref. 3758 EPDM	 Ref. 3759 EPDM	 Ref. 3760 RG+FL
 Ref. 3763 FL	 Ref. 3762 RG+FL	
 Ref. 3764 RG+FL	 Ref. 3765 EPDM	 Ref. 3766 EPDM
 Ref. 3767 EPDM	 Ref. 3768 EPDM	 Ref. 3769 EPDM
 Ref. 3770 EPDM	 Ref. 3771 EPDM	 Ref. 3772 EPDM



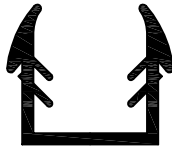





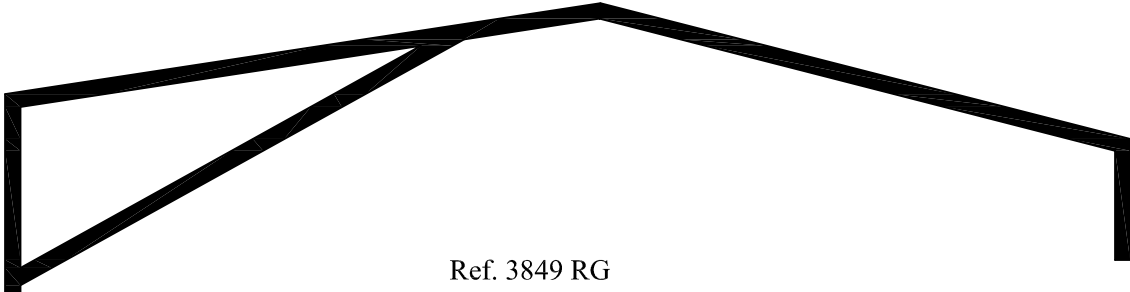
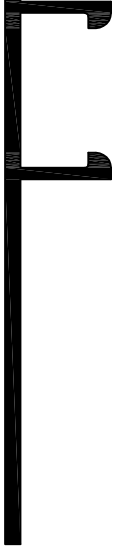

 <p>Ref. 3773 EPDM</p>	 <p>Ref. 3777 EPDM</p>	 <p>Ref. 3778 EPDM EXP.</p>
 <p>Ref. 3779 RG+FL</p>	 <p>Ref. 3780 RG+FL</p>	 <p>Ref. 3781 EPDM</p>
 <p>Ref. 3782 EPDM</p>	 <p>Ref. 3784 EPDM</p>	 <p>Ref. 3786 RG</p>
 <p>Ref. 3787 EPDM</p>	 <p>Ref. 3788 EPDM</p>	 <p>Ref. 3789 EPDM</p>
 <p>Ref. 3790 RG+RG</p>	 <p>Ref. 3791 EPDM</p>	 <p>Ref. 3792 EPDM</p>

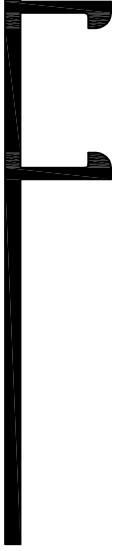

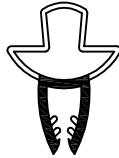

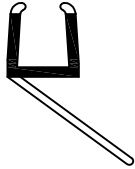



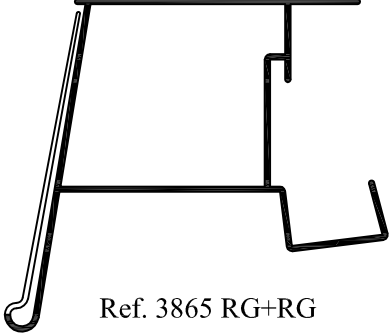

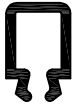

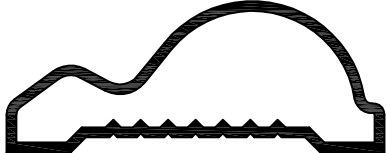
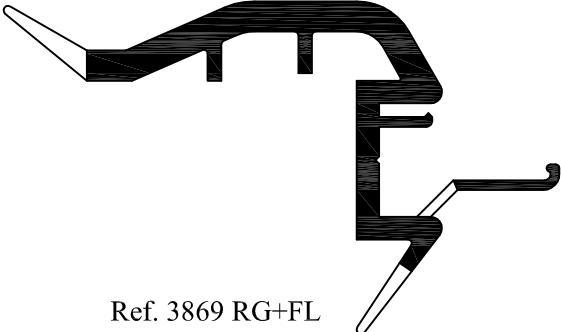
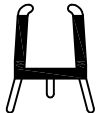
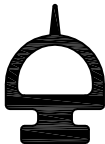







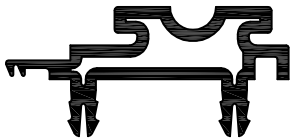
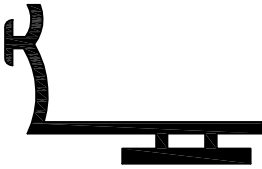

 Ref. 3793 RG+FL	 Ref. 3796 EPDM	 Ref. 3797 EPDM
 Ref. 3798 EPDM	 Ref. 3799 EPDM	 Ref. 3800 RG+FL
 Ref. 3803 RG+FL	 Ref. 3804 RG	 Ref. 3805 RG+FL
 Ref. 3807 FL	 Ref. 3808 FL	 Ref. 3809 FL
 Ref. 3810 RG+FL	 Ref. 3811 RG+FL	 Ref. 3812 FL

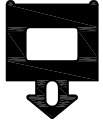

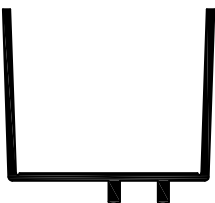
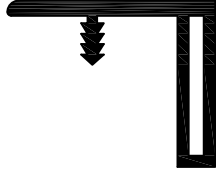



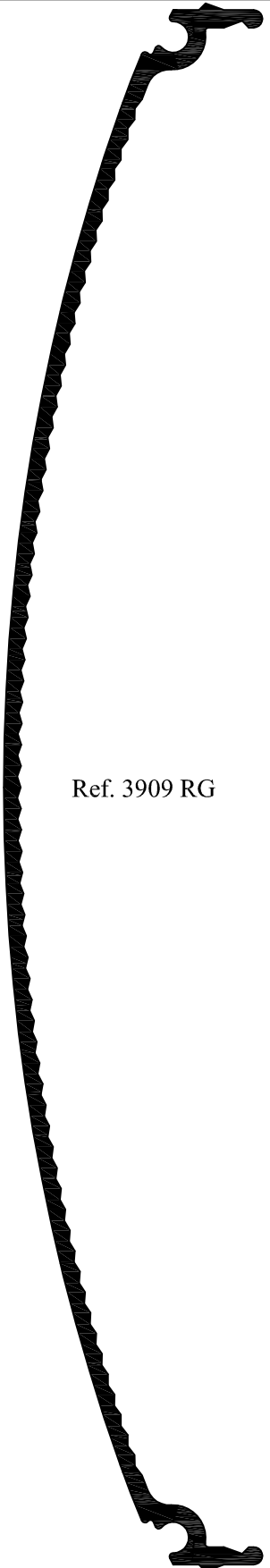

 Ref. 3813 FL	 Ref. 3814 FL	 Ref. 3815 RG
 Ref. 3818 EPDM	 Ref. 3820 EPDM	 Ref. 3821 EPDM
 Ref. 3822 EPDM	 Ref. 3823 EPDM	 Ref. 3824 FL
 Ref. 3826 FL	 Ref. 3828 EPDM	 Ref. 3830 RG
 Ref. 3831 RG	 Ref. 3832 RG+FL	 Ref. 3833 RG

 Ref. 3834 RG	 Ref. 3835 FL+PE	 Ref. 3836 EPDM
 Ref. 3837 EPDM	 Ref. 3838 RG+FL	 Ref. 3839 RG
 Ref. 3840 EPDM	 Ref. 3841 EPDM	 Ref. 3842 EPDM
 Ref. 3843 EPDM	 Ref. 3844 FL	 Ref. 3845 RG+FL
 Ref. 3846 EPDM	 Ref. 3848 RG+FL	 Ref. 3850 RG+FL

		
Ref. 3849 RG		
		
	Ref. 3851 RG	Ref. 3857 RG
		
	Ref. 3858 EPDM	Ref. 3859 RG+FL
		
Ref. 3860 RG+FL	Ref. 3861 RG+FL	Ref. 3862 RG+FL
		
Ref. 3863 RG+FL	Ref. 3864 RG+FL	Ref. 3865 RG+RG

 <p>Ref. 3866 RG</p>	 <p>Ref. 3867 EPDM</p>	 <p>Ref. 3868 RG</p>
 <p>Ref. 3869 RG+FL</p>		 <p>Ref. 3870 RG+FL</p>
 <p>Ref. 3871 FL</p>	 <p>Ref. 3872 RG</p>	 <p>Ref. 3874 EPDM</p>
 <p>Ref. 3875 RG+CA</p>	 <p>Ref. 3876 EPDM</p>	 <p>Ref. 3878 EPDM</p>
 <p>Ref. 3877 RG</p>		 <p>Ref. 3883 FL</p>

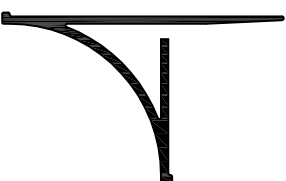
 <p>Ref. 3884 EPDM</p>	 <p>Ref. 3885 RG</p>	 <p>Ref. 3886 EPDM</p>
 <p>Ref. 3887 RG+FL</p>	 <p>Ref. 3888 EPDM</p>	 <p>Ref. 3889 EPDM</p>
 <p>Ref. 3892 RG+FL</p>	 <p>Ref. 3893 FL</p>	 <p>Ref. 3899 RG</p>
 <p>Ref. 3900 RG</p>	 <p>Ref. 3905 EPDM</p>	 <p>Ref. 3907 RG</p>
 <p>Ref. 3908 RG+FL</p>	 <p>Ref. 3910 FL</p>	 <p>Ref. 3911 RG</p>

 <p>Ref. 3909 RG</p>	 <p>Ref. 3912 EPDM</p>	 <p>Ref. 3913 FL</p>
	 <p>Ref. 3914 RG</p>	
	 <p>Ref. 3915 EPDM</p>	 <p>Ref. 3916 EPDM</p>
	 <p>Ref. 3917 FL+PE</p>	 <p>Ref. 3918 RG</p>
	 <p>Ref. 3919 EPDM</p>	 <p>Ref. 3920 RG</p>



Ref. 3922 RG



Ref. 3923 RG



Ref. 3925 RG+FL



Ref. 3927 RG+FL

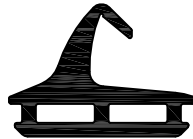

Ref. 3928 EPDM



Ref. 3930 FL

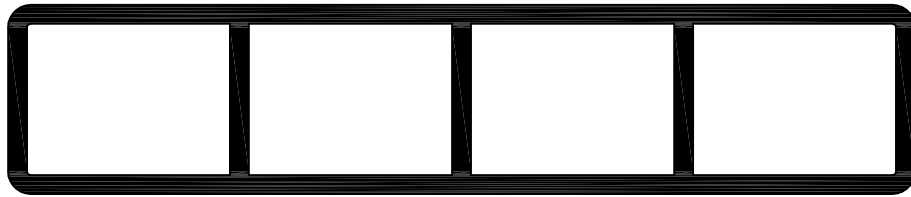

Ref. 3929 RG



Ref. 3931 EPDM



Ref. 3932 FL



Ref. 3933 FL



Ref. 3934 EPDM













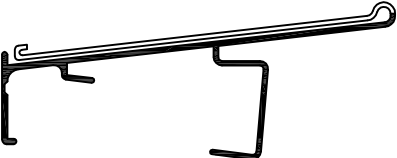
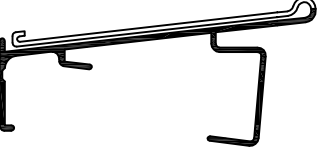



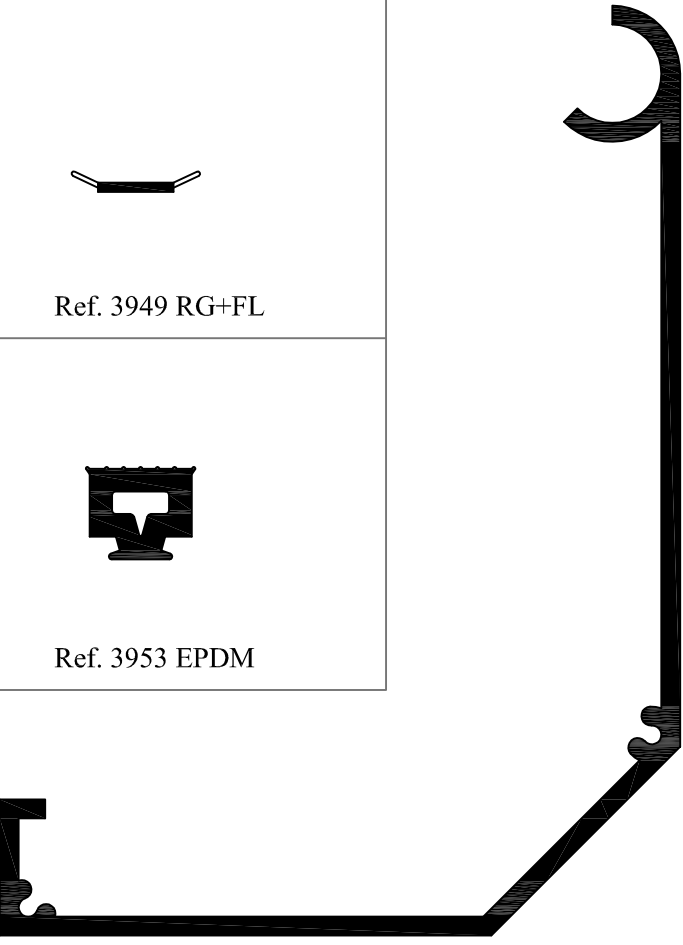





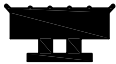

Ref. 3936 EPDM

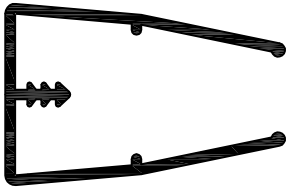

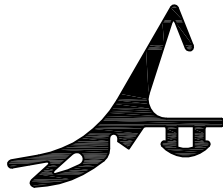







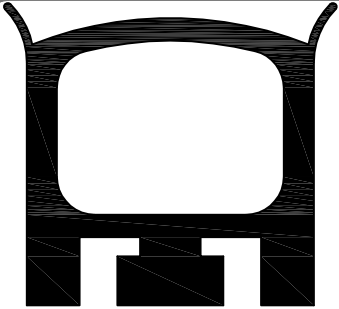





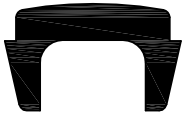

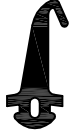







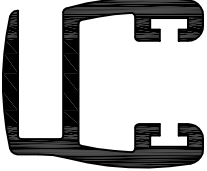

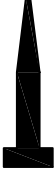
Ref. 3937 FL











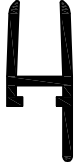
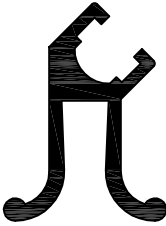



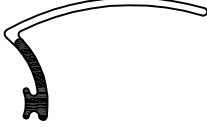

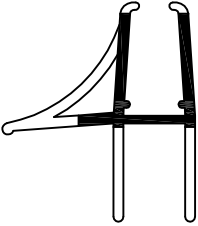

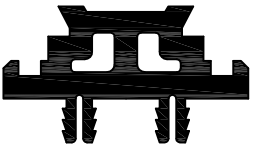
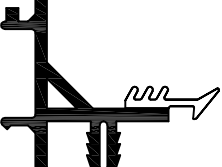





 <p>Ref. 3939 RG+FL</p>	 <p>Ref. 3940 EPDM</p>	 <p>Ref. 3943 RG+FL</p>
 <p>Ref. 3944 RG+RG</p>	 <p>Ref. 3945 RG+RG</p>	 <p>Ref. 3946 RG</p>
 <p>Ref. 3947 FL+PE</p>	 <p>Ref. 3949 RG+FL</p>	 <p>Ref. 3942 RG</p>
 <p>Ref. 3952 RG+FL</p>	 <p>Ref. 3953 EPDM</p>	
 <p>Ref. 3954 EPDM</p>		







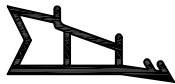
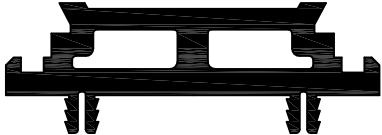
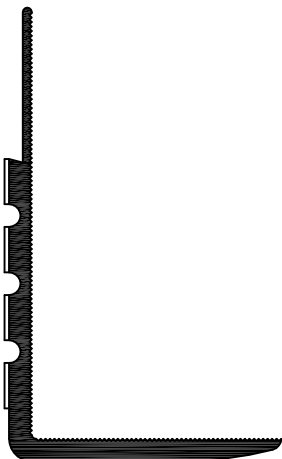



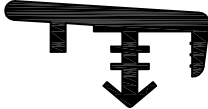

 <p>Ref. 3955 EPDM</p>	 <p>Ref. 3956 EPDM</p>	 <p>Ref. 3957 EPDM</p>
 <p>Ref. 3958 RG</p>	 <p>Ref. 3959 RG</p>	 <p>Ref. 3960 EPDM</p>
 <p>Ref. 3961 EPDM</p>		 <p>Ref. 3963 EPDM</p>
 <p>Ref. 3964 EPDM</p>	 <p>Ref. 3965 EPDM</p>	 <p>Ref. 3966 EPDM</p>
 <p>Ref. 3967 RG</p>	 <p>Ref. 3968 RG</p>	 <p>Ref. 3970 RG+FL</p>

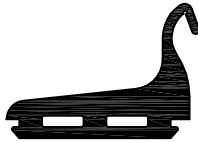

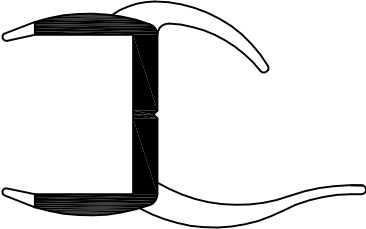

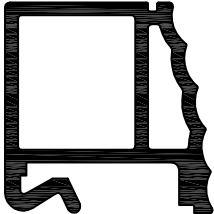



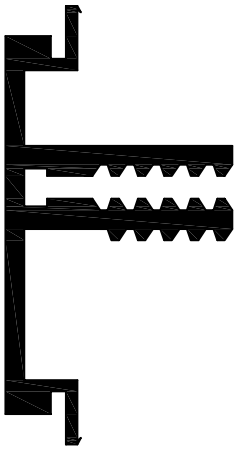

 <p>Ref. 3971 EPDM</p>	 <p>Ref. 3972 RG+FL</p>	 <p>Ref. 3973 FL</p>
 <p>Ref. 3974 EPDM</p>	 <p>Ref. 3975 RG+FL+ADH</p>	 <p>Ref. 3976 EPDM</p>
 <p>Ref. 3977 RG</p>	 <p>Ref. 3979 FL</p>	 <p>Ref. 3980 FL</p>
 <p>Ref. 3978 RG</p>		 <p>Ref. 3981 EPDM</p>
 <p>Ref. 3982 RG+FL</p>	 <p>Ref. 3984 FL</p>	 <p>Ref. 3985 EPDM</p>

 <p>Ref. 3986 RG+FL</p>	 <p>Ref. 3990 FL</p>	 <p>Ref. 3992 RG</p>
 <p>Ref. 3993 RG</p>	 <p>Ref. 3994 FL</p>	 <p>Ref. 3996 RG+FL</p>
 <p>Ref. 3997 RG+FL</p>	 <p>Ref. 3998 RG+FL</p>	 <p>Ref. 4000 EPDM</p>
 <p>Ref. 3999 RG</p>		 <p>Ref. 4001 RG+FL</p>
 <p>Ref. 4002 RG</p>	 <p>Ref. 4005 FL</p>	 <p>Ref. 4006 FL</p>

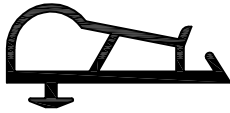

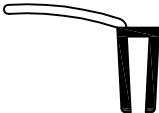

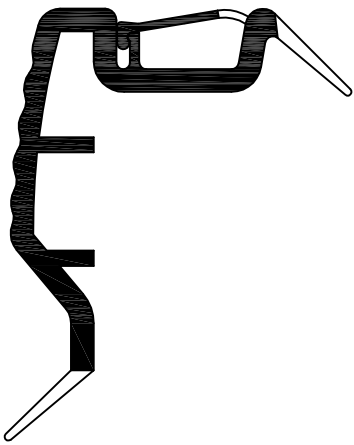
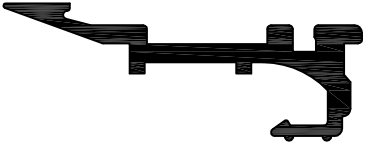



 Ref. 4007 FL	 Ref. 4008 FL	 Ref. 4009 EPDM
 Ref. 4010 EPDM	 Ref. 4011 RG+FL	 Ref. 4012 RG+FL
 Ref. 4013 RG	 Ref. 4014 RG+FL	 Ref. 4015 FL
 Ref. 4016 RG	 Ref. 4017 RG+FL	 Ref. 4018 EPDM
 Ref. 4019 EPDM	 Ref. 4020 EPDM	 Ref. 4021 EPDM





 <p>Ref. 4022 RG</p>		 <p>Ref. 4023 RG</p>
 <p>Ref. 4024 RG</p>	 <p>Ref. 4025 RG</p>	 <p>Ref. 4026 RG+FL</p>
 <p>Ref. 4027 FL</p>	 <p>Ref. 4028 RG+FL</p>	 <p>Ref. 4029 EPDM</p>
 <p>Ref. 4030 FL</p>	 <p>Ref. 4031 RG</p>	 <p>Ref. 4033 FL+FL</p>
 <p>Ref. 4032 RG</p>	 <p>Ref. 4035 FL</p>	

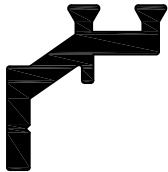
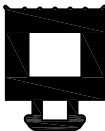
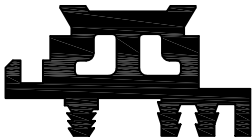
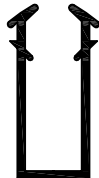

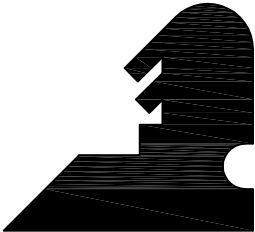

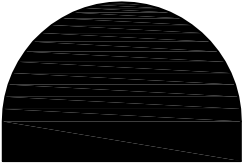
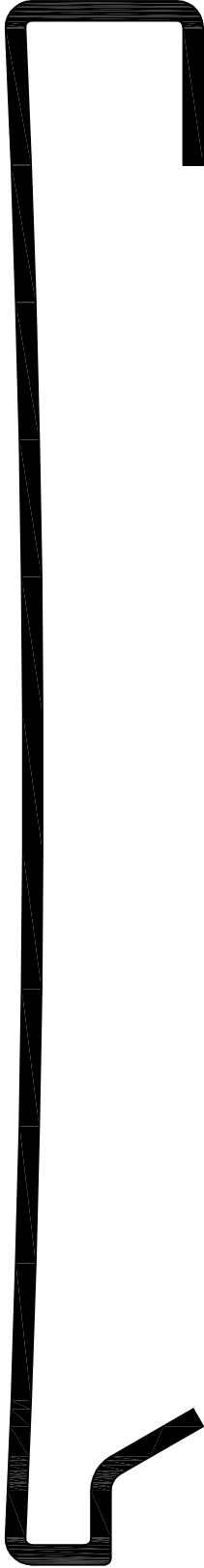
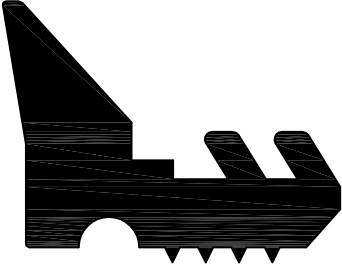

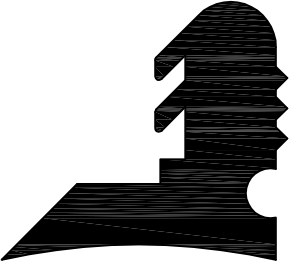
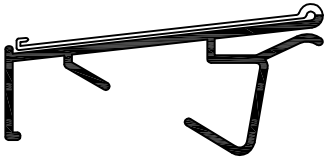
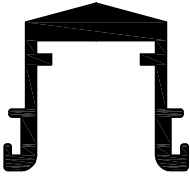

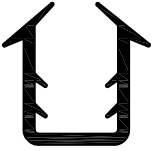

 <p>Ref. 4037 FL</p>	 <p>Ref. 4038 FL</p>	 <p>Ref. 4039 RG</p>
 <p>Ref. 4040 RG</p>		 <p>Ref. 4042 EPDM</p>
 <p>Ref. 4043 FL</p>	 <p>Ref. 4044 RG+FL</p>	 <p>Ref. 4045 EPDM</p>
 <p>Ref. 4046 FL</p>	 <p>Ref. 4047 RG</p>	 <p>Ref. 4048 RG+FL</p>
 <p>Ref. 4049 RG</p>	 <p>Ref. 4050 EPDM</p>	 <p>Ref. 4052 RG</p>

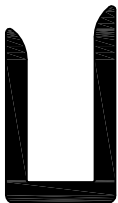
 <p>Ref. 4051 RG</p>	 <p>Ref. 4053 FL</p>	 <p>Ref. 4054 RG+FL</p>
	 <p>Ref. 4055 EPDM</p>	 <p>Ref. 4056 FL</p>
 <p>Ref. 4057 RG</p>	 <p>Ref. 4058 FL</p>	 <p>Ref. 4060 RG+FL</p>
 <p>Ref. 4062 FL</p>	 <p>Ref. 4063 RG</p>	 <p>Ref. 4066 RG+FL</p>
 <p>Ref. 4064 RG</p>	 <p>Ref. 4065 RG+FL</p>	

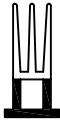

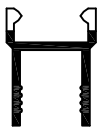
 <p>Ref. 4067 EPDM</p>	 <p>Ref. 4068 EPDM</p>	 <p>Ref. 4069 EPDM</p>
 <p>Ref. 4070 EPDM</p>	 <p>Ref. 4071 EPDM</p>	 <p>Ref. 4072 RG+FL</p>
 <p>Ref. 4074 EPDM</p>		
 <p>Ref. 4075 RG</p>	 <p>Ref. 4076 EPDM</p>	 <p>Ref. 4077 EPDM</p>
 <p>Ref. 4078 FL</p>	 <p>Ref. 4079 FL</p>	 <p>Ref. 4080 FL</p>

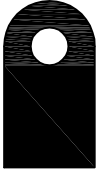
		
Ref. 4083 FL	Ref. 4084 FL	
		
Ref. 4085 FL	Ref. 4086 RG+FL	
		
Ref. 4087 RG+FL	Ref. 4088 FL	
		
Ref. 4089 RG+RG	Ref. 4090 RG	
		Ref. 4081 RG
Ref. 4091 EPDM	Ref. 4092 RG	

 <p>Ref. 4093 FL</p>	 <p>Ref. 4094 FL</p>	 <p>Ref. 4095 RG</p>
 <p>Ref. 4096 RG</p>	 <p>Ref. 4097 RG</p>	 <p>Ref. 4098 FL</p>
 <p>Ref. 4099 RG+FL</p>	 <p>Ref. 4100 EPDM</p>	 <p>Ref. 4101 FL</p>
 <p>Ref. 4102 RG+FL</p>	 <p>Ref. 4103 RG</p>	 <p>Ref. 4104 FL</p>
 <p>Ref. 4105 FL</p>	 <p>Ref. 4106 RG</p>	

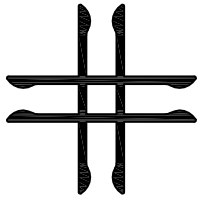

Ref. 4107 + RG



Ref. 4107 L RG

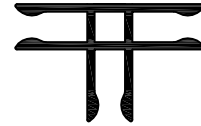

Ref. 4107 T RG



Ref. 4108 FL



Ref. 4109 EPDM

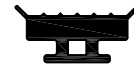

Ref. 4110 EPDM

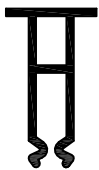

Ref. 4111 RG



Ref. 4112 FL



Ref. 4113 EPDM



Ref. 4114 FL



Ref. 4115 RG



Ref. 4116 FL





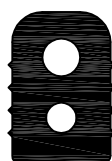









Ref. 4117 FL

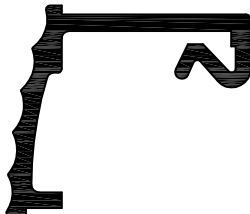

Ref. 4118 FL



Ref. 4119 FL

 <p>Ref. 4120 FL</p>	 <p>Ref. 4121 RG</p>	 <p>Ref. 4122 RG+FL</p>
 <p>Ref. 4123 FL</p>	 <p>Ref. 4124 FL</p>	 <p>Ref. 4125 RG</p>
 <p>Ref. 4126 RG</p>		
 <p>Ref. 4127 EPDM</p>	 <p>Ref. 4128 FL</p>	 <p>Ref. 4129 RG</p>
 <p>Ref. 4130 FL</p>	 <p>Ref. 4131 FL</p>	 <p>Ref. 4132 FL</p>



Ref. 4133 RG+FL



Ref. 4134 RG



Ref. 4135 RG



Ref. 4136 RG

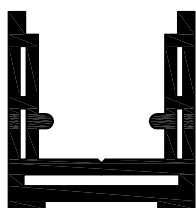

Ref. 4137 RG



Ref. 4138 RG



Ref. 4139 FL



Ref. 4140 FL

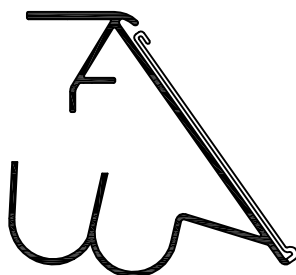

Ref. 4141 RG+RG



Ref. 4142 RG



Ref. 4143 RG



Ref. 4144 FL

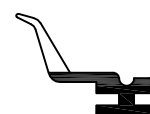

Ref. 4145 RG+FL

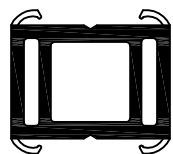

Ref. 4146 RG+FL



Ref. 4147 FL

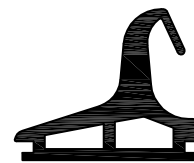

Ref. 4148 EPDM

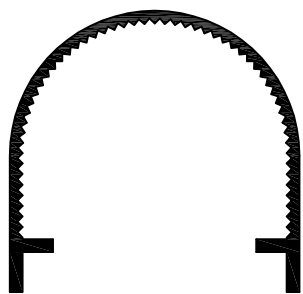

Ref. 4149 RG



Ref. 4150 RG



Ref. 4151 RG



Ref. 4152 FL



Ref. 4153 FL



Ref. 4154 FL

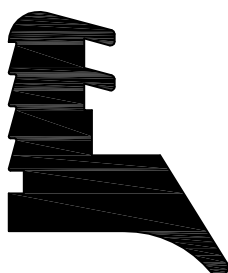











Ref. 4156 FL

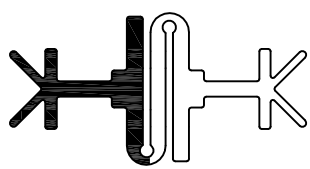
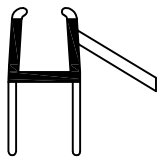

Ref. 4157 EPDM

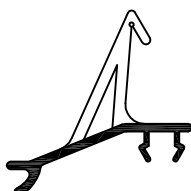

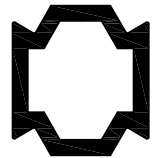
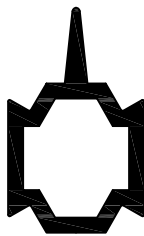















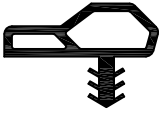

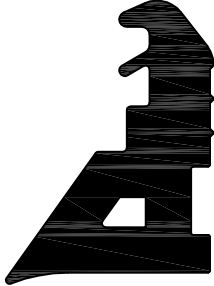

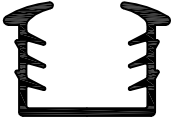







Ref. 4158 FL













 <p>Ref. 4159 FL</p>	 <p>Ref. 4160 FL</p>	 <p>Ref. 4161 FL</p>
 <p>Ref. 4162 RG</p>	 <p>Ref. 4163 RG+FL</p>	 <p>Ref. 4164 RG+FL</p>
 <p>Ref. 4165 RG+FL</p>	 <p>Ref. 4166 RG+FL</p>	 <p>Ref. 4167 RG+FL</p>
 <p>Ref. 4169 RG</p>		
 <p>Ref. 4168 RG</p>	 <p>Ref. 4168 A RG</p>	 <p>Ref. 4170 FL</p>











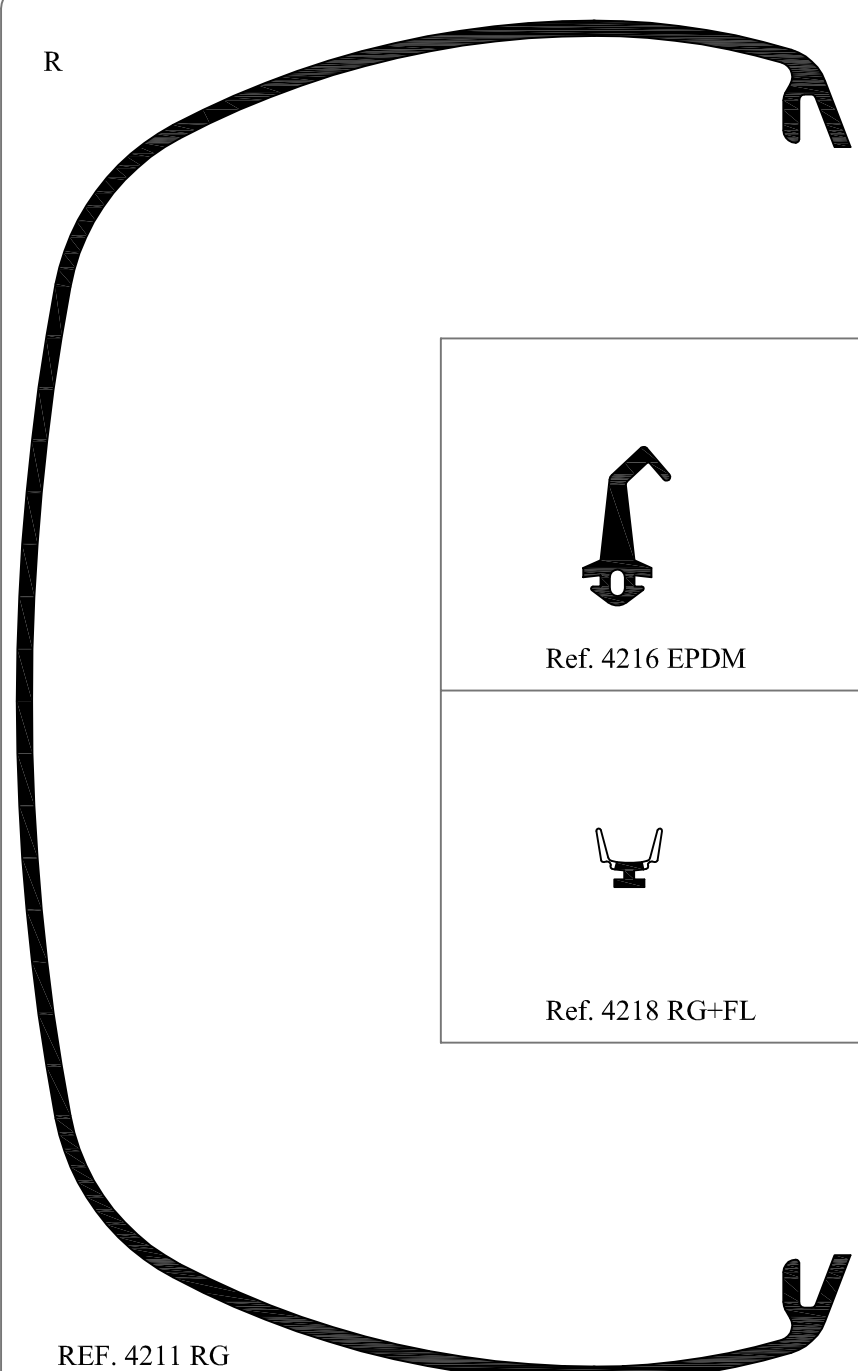







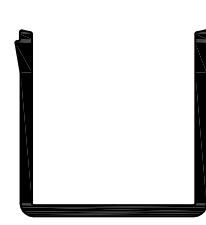







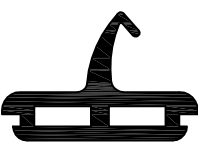





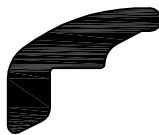



 Ref. 4171 FL	 Ref. 4172 RG	 Ref. 4173 RG
 Ref. 4174 RG	 Ref. 4175 FL	 Ref. 4176 RG+FL
 Ref. 4177 RG+FL	 Ref. 4178 FL	 Ref. 4179 FL
 Ref. 4180 FL	 Ref. 4181 FL	 Ref. 4182 FL
 Ref. 4183 RG+FL	 Ref. 4184 FL	 Ref. 4185 RG+FL



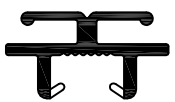

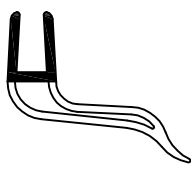

		
Ref. 4186 RG	Ref. 4187 RG	Ref. 4188 RG
		
Ref. 4189 RG+FL	Ref. 4190 FL	Ref. 4191 FL
		
Ref. 4192 FL	Ref. 4193 FL	Ref. 4194 RG+FL
		
Ref. 4195 EPDM	Ref. 4196 EPDM	Ref. 4197 RG+FL
		
Ref. 4198 FL	Ref. 4199 FL	Ref. 4200 FL

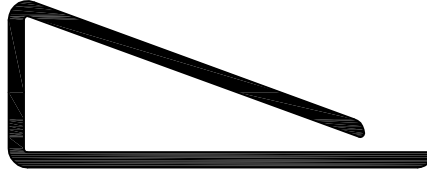
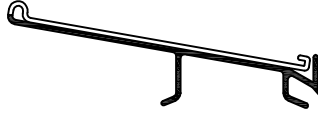
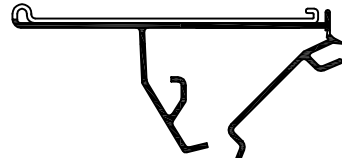

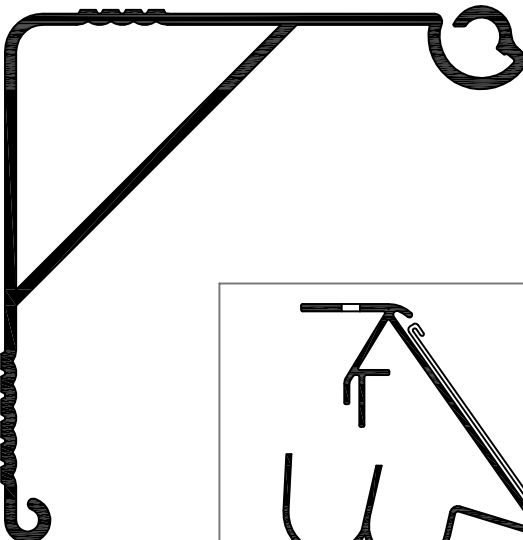
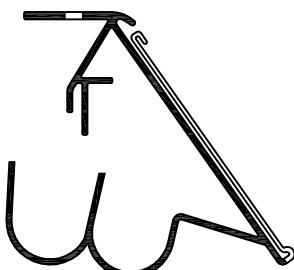
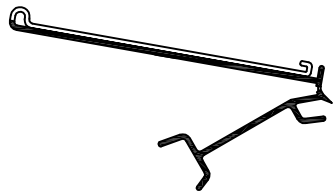
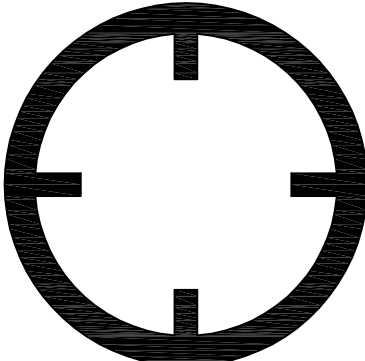







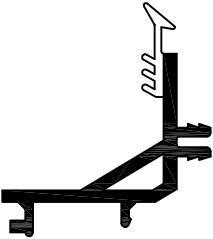



 Ref. 4201 RG	 Ref. 4202 EPDM	 Ref. 4203 EPDM
 Ref. 4204 EPDM	 Ref. 4205 EPDM	 Ref. 4206 EPDM
 REF. 4207 RG		 Ref. 4208 FL
 Ref. 4209 FL	 Ref. 4210 RG	
 Ref. 4212 RG	 Ref. 4213 FL	 Ref. 4214 FL

 <p>R</p> <p>REF. 4211 RG</p>	 <p>Ref. 4215 RG+FL</p>	
	 <p>Ref. 4216 EPDM</p>	 <p>Ref. 4217 RG</p>
	 <p>Ref. 4218 RG+FL</p>	 <p>Ref. 4219 RG</p>
	 <p>Ref. 4220 RG</p>	
 <p>Ref. 4221 RG+FL</p>	 <p>Ref. 4222 RG</p>	 <p>Ref. 4223 RG</p>

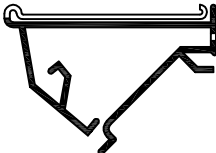

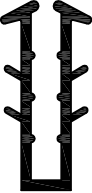



 Ref. 4224 EPDM	 Ref. 4225 EPDM	 Ref. 4226 EPDM
 Ref. 4227 FL+FL EXP.	 Ref. 4228 EPDM	 Ref. 4229 EPDM
 Ref. 4230 EPDM	 Ref. 4231 EPDM	 Ref. 4232 RG
 Ref. 4233 FL	 Ref. 4234 RG	 Ref. 4235 RG
 Ref. 4236 EPDM	 Ref. 4237 EPDM	R  Ref. 4238 RG





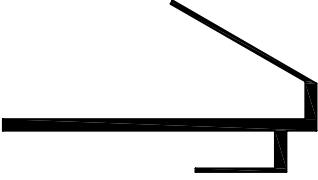

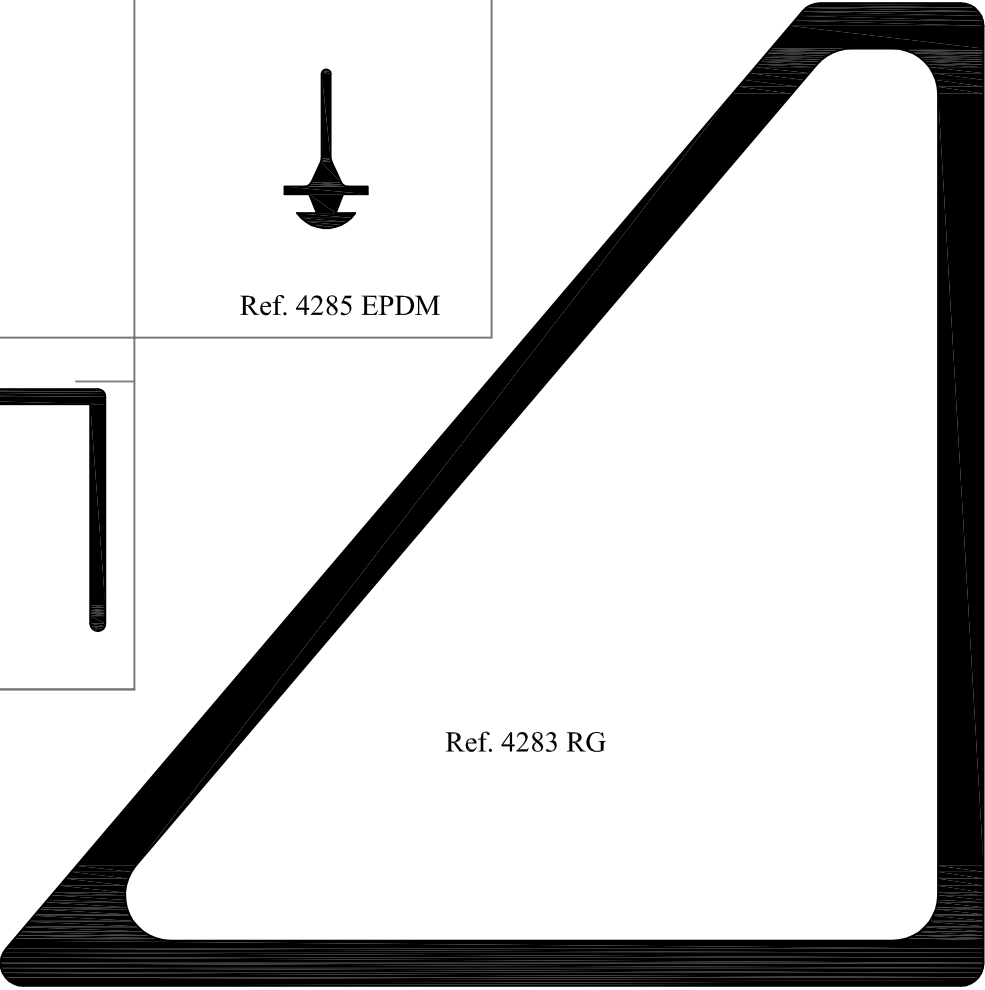
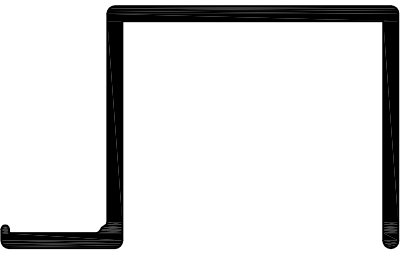
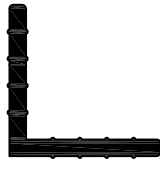
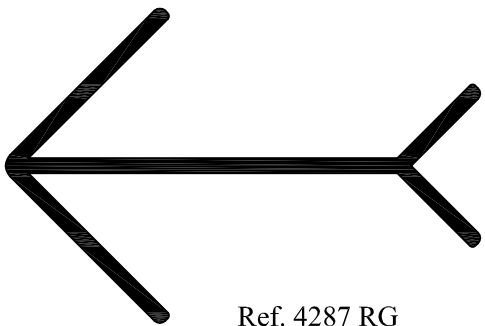
<p>R</p>  <p>Ref. 4239 RG</p>	 <p>Ref. 4240 RG</p>	
 <p>Ref. 4244 RG+FL</p>	 <p>Ref. 4241 FL</p>	 <p>Ref. 4242 RG</p>
 <p>Ref. 4247 RG+FL</p>	 <p>Ref. 4245 RG</p>	 <p>Ref. 4246 RG</p>
 <p>Ref. 4250 RG</p>	 <p>Ref. 4248 FL</p>	 <p>Ref. 4249 FL</p>
	 <p>Ref. 4252 RG+RG</p>	 <p>Ref. 4253 RG+RG+FL</p>



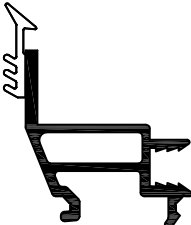
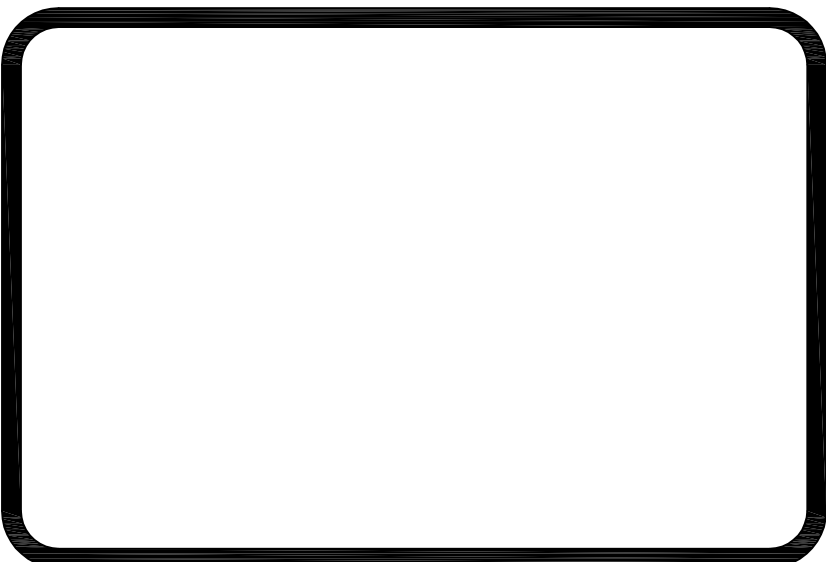

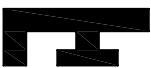
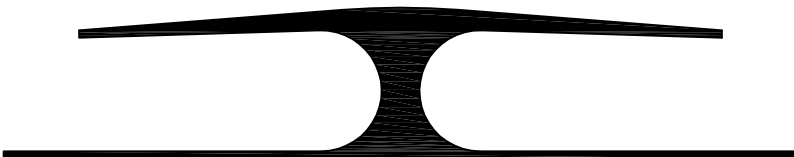

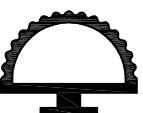



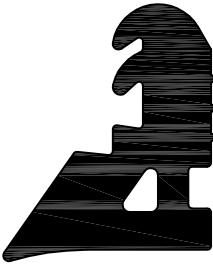

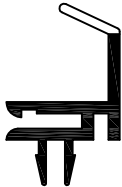
 <p>Ref. 4251 RG</p>	 <p>Ref. 4256 RG+RG+FL</p>	 <p>Ref. 4254 RG+RG+FL</p>
 <p>Ref. 4255 RG</p>	 <p>Ref. 4258 FL</p>	 <p>Ref. 4259 FL</p>
 <p>Ref. 4262 EPDM</p>	 <p>Ref. 4263 RG+FL</p>	 <p>Ref. 4261 EPDM</p>
		 <p>Ref. 4264 FL</p>



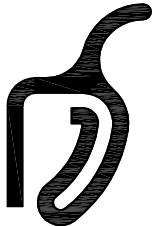



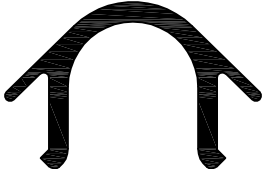





 <p>Ref. 4265 RG+FL</p>	 <p>Ref. 4266 EPDM</p>	
 <p>Ref. 4268 FL</p>	 <p>Ref. 4269 RG</p>	 <p>Ref. 4270 FL</p>
 <p>Ref. 4271 FL</p>	 <p>Ref. 4272 PP+FL EXP</p>	 <p>Ref. 4273 RG+RG+FL</p>
 <p>Ref. 4274 FL</p>	 <p>Ref. 4275 FL</p>	 <p>Ref. 4276 FL</p>
 <p>Ref. 4277 RG</p>	<p>R</p>  <p>Ref. 4278 RG</p>	<p>R</p>  <p>Ref. 4279 FL</p>





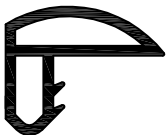
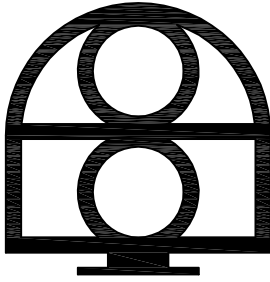





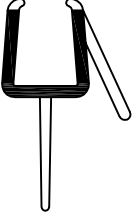



<p>R</p>  <p>Ref. 4280 FL</p>	 <p>Ref. 4281 FL</p>	 <p>Ref. 4282 FL</p>
 <p>Ref. 4284 EPDM</p>	 <p>Ref. 4285 EPDM</p>	 <p>Ref. 4283 RG</p>
 <p>Ref. 4286 RG</p>		
<p>R</p>  <p>Ref. 4288 RG</p>		
 <p>Ref. 4287 RG</p>		 <p>Ref. 4291 EPDM</p>

 <p>Ref. 4289 FL</p>	 <p>Ref. 4292 RG+FL</p>	
<p>R</p>  <p>Ref. 4290 RG</p>	 <p>Ref. 4294 RG+FL</p>	
	<p>R</p>  <p>Ref. 4295 RG</p>	
 <p>Ref. 4293 FL</p>	 <p>Ref. 4296 EPDM</p>	
 <p>Ref. 4298 FL</p>	 <p>Ref. 4299 FL</p>	<p>R</p>  <p>Ref. 4300 FL</p>

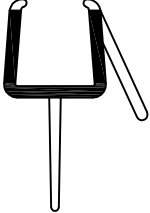
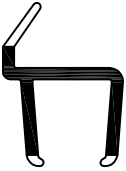
 Ref. 4301 FL	R  Ref. 4302 RG	R  Ref. 4303 RG+FL
 Ref. 4304 RG+FL	 Ref. 4305 FL	R  Ref. 4306 RG
R  Ref. 4307 RG		R  Ref. 4308 FL
 Ref. 4309 FL	 Ref. 4310 FL	 Ref. 4311 FL+FL EXP
R  Ref. 4312 RG	 Ref. 4313 RG+FL	 Ref. 4314 RG+FL

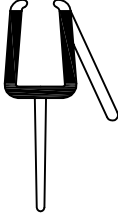
<p>R</p>  <p>Ref. 4315 RG+FL</p>	<p>R</p>  <p>Ref. 4316 RG</p>	 <p>Ref. 4317 FL</p>
 <p>Ref. 4318 FL</p>	 <p>Ref. 4319 EPDM</p>	 <p>Ref. 4320 EPDM</p>
<p>R</p>  <p>Ref. 4321 FL</p>	<p>R</p>  <p>Ref. 4323 RG</p>	
 <p>Ref. 4322 FL</p>	<p>R</p>  <p>Ref. 4325 FL</p>	<p>R</p>  <p>Ref. 4324 FL</p>
 <p>Ref. 4326 FL</p>	<p>R</p>  <p>Ref. 4327 FL</p>	

R  Ref. 4328 RG+FL	R  Ref. 4329 RG+FL	R  Ref. 4330 RG+FL
 Ref. 4331 FL	 Ref. 4332 FL	 Ref. 4333 FL
 Ref. 4334 FL	 Ref. 4335 FL	R  Ref. 4336 RG+FL
R  Ref. 4337 RG+FL	R  Ref. 4338 RG+FL	R  Ref. 4339 RG+FL
R  Ref. 4340 RG+FL	R  Ref. 4341 RG+FL	R  Ref. 4345 FL

R

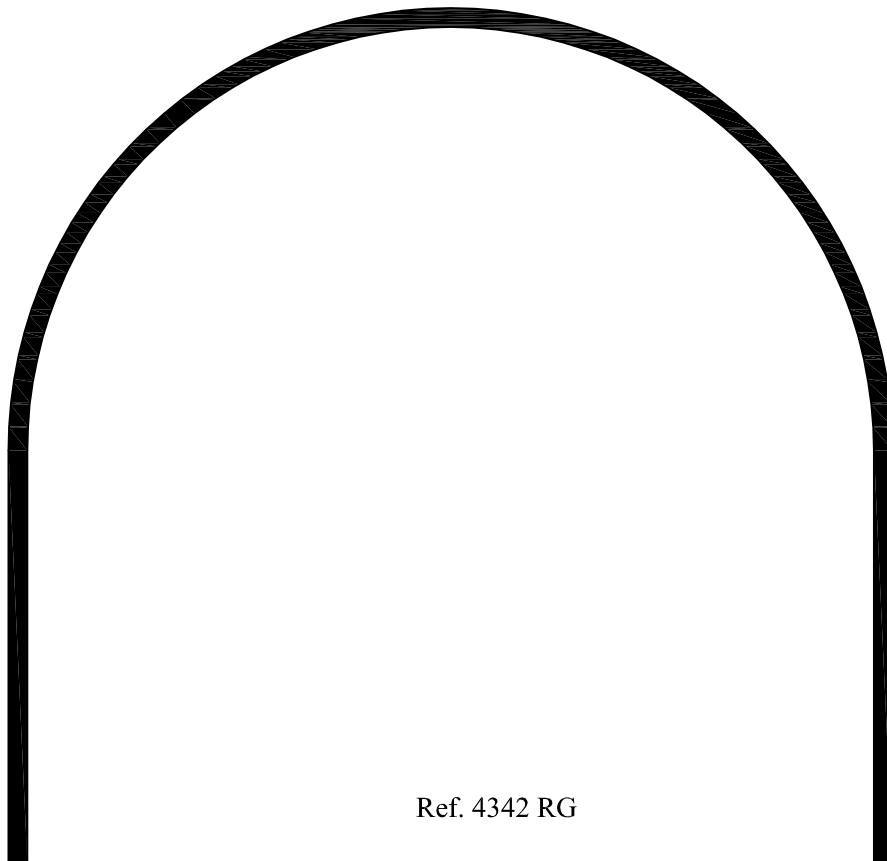





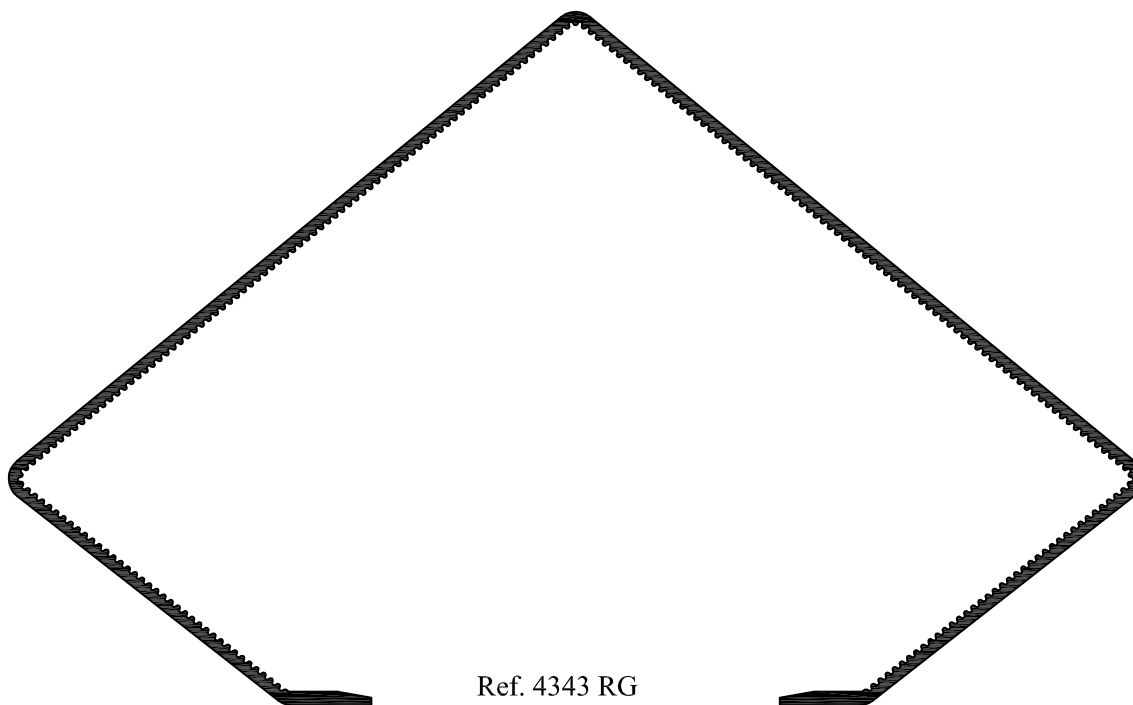





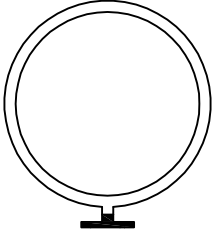



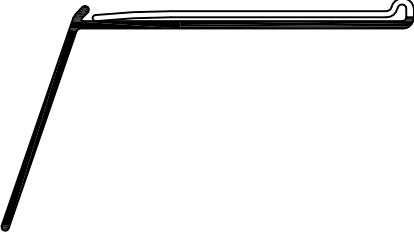
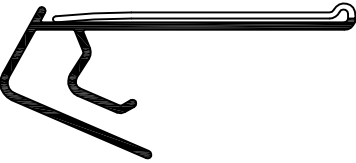

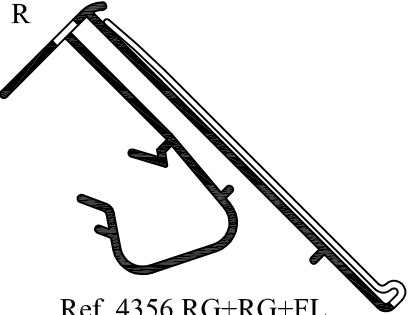

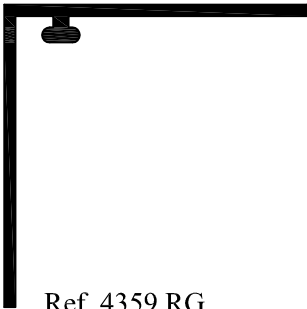

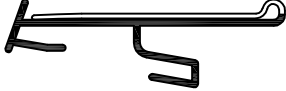

Ref. 4342 RG

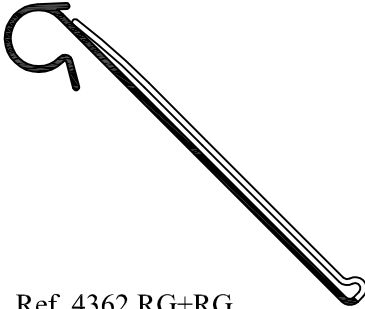
R

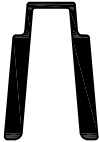









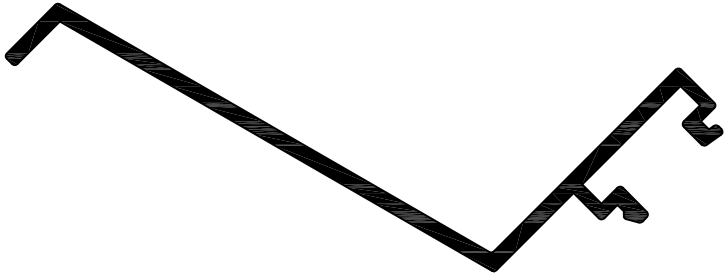

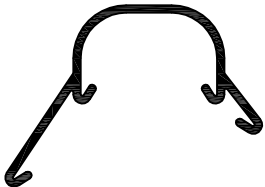







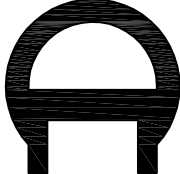

Ref. 4343 RG





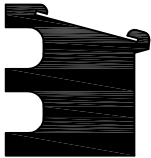

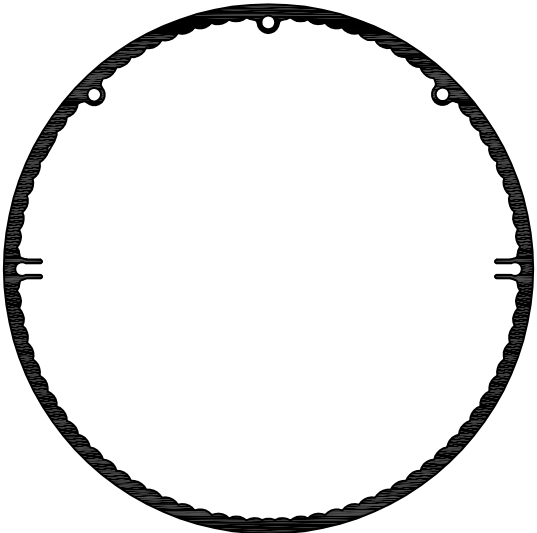

<p>R</p>  <p>Ref. 4344 FL</p>	<p>R</p>  <p>Ref. 4346 RG</p>	
 <p>Ref. 4347 RG+FL</p>	<p>R</p>  <p>Ref. 4348 RG+FL</p>	<p>R</p>  <p>Ref. 4349 FL</p>
<p>R</p>  <p>Ref. 4350 RG+RG</p>	<p>R</p>  <p>Ref. 4351 RG</p>	<p>R</p>  <p>Ref. 4352 RG+RG</p>
<p>R</p>  <p>Ref. 4353 RG+RG</p>	 <p>Ref. 4354 FL</p>	 <p>Ref. 4355 FL</p>
<p>R</p>  <p>Ref. 4356 RG+RG+FL</p>	<p>R</p>  <p>Ref. 4357 RG</p>	<p>R</p>  <p>Ref. 4359 RG</p>

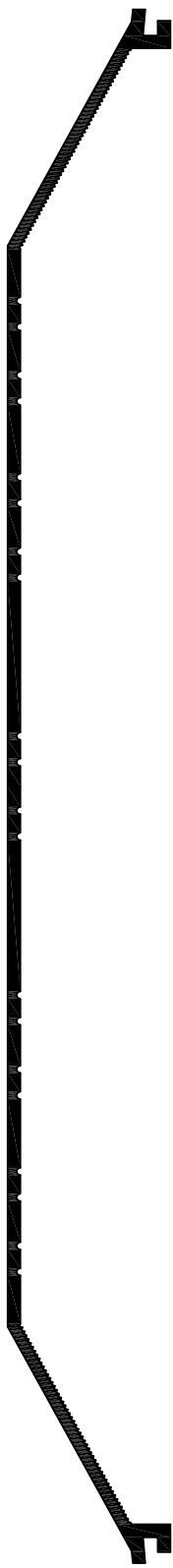

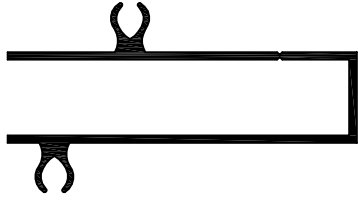





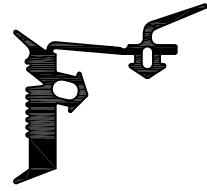





<p>R</p>  <p>Ref. 4358 FL</p>	<p>R</p>  <p>Ref. 4360 RG+RG</p>	
<p>R</p>  <p>Ref. 4361 RG+RG</p>	<p>R</p>  <p>Ref. 4362 RG+RG</p>	<p>R</p>  <p>Ref. 4364 RG+RG+FL</p>
<p>R</p>  <p>Ref. 4363 RG+RG+FL</p>		
<p>R</p>  <p>Ref. 4365 RG</p>	<p>R</p>  <p>Ref. 4366 RG</p>	<p>R</p>  <p>Ref. 4367 RG</p>
<p>R</p>  <p>Ref. 4368 RG</p>	<p>R</p>  <p>Ref. 4369 RG</p>	<p>R</p>  <p>Ref. 4370 RG</p>













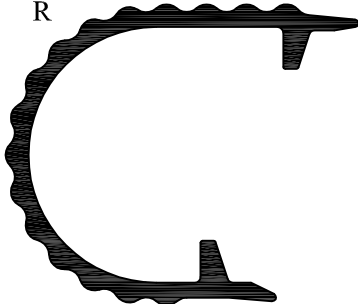
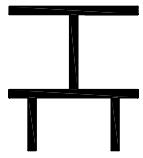
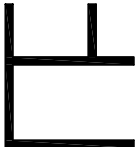
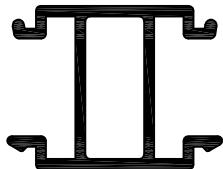









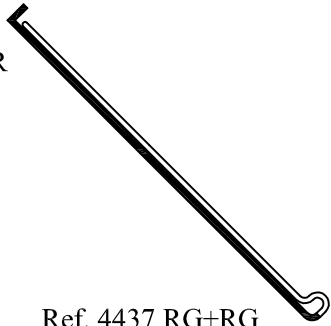

 <p>Ref. 4371 RG</p>		<p>R</p>  <p>Ref. 4372 RG</p>
<p>R</p>  <p>Ref. 4373 RG</p>	 <p>Ref. 4374 RG+FL</p>	 <p>Ref. 4376 RG</p>
 <p>Ref. 4375 FL</p>	<p>R</p>  <p>Ref. 4378 RG+FL</p>	<p>R</p>  <p>Ref. 4377 RG</p>
 <p>Ref. 4379 FL</p>	 <p>Ref. 4380 FL</p>	<p>R</p>  <p>Ref. 4381 RG+FL</p>
 <p>Ref. 4382 RG</p>	 <p>Ref. 4383 RG</p>	 <p>Ref. 4384 EPDM</p>





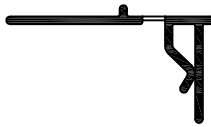
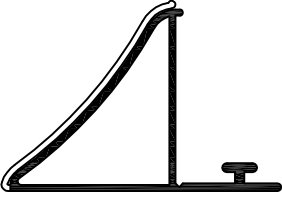

<p>R</p>  <p>Ref. 4387 RG</p>		
<p>R</p>  <p>Ref. 4385 PMMA+PMMA</p>	<p>R</p>  <p>Ref. 4386 FL</p>	<p>R</p>  <p>Ref. 4388 RG</p>
 <p>Ref. 4389 FL</p>	<p>R</p>  <p>Ref. 4390 RG</p>	<p>R</p>  <p>Ref. 4393 RG+FL</p>
<p>R</p>  <p>Ref. 4391 RG</p>		<p>R</p>  <p>Ref. 4394 RG+FL</p>
		<p>R</p>  <p>Ref. 4395 RG</p>



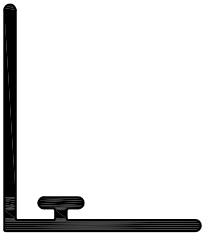

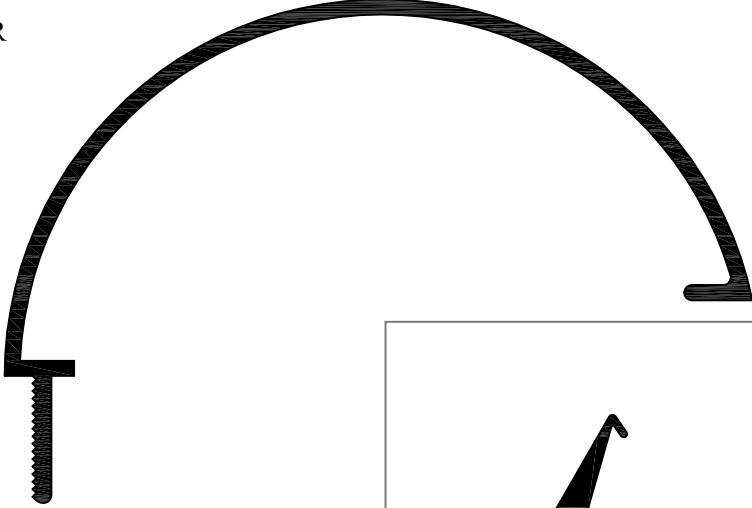

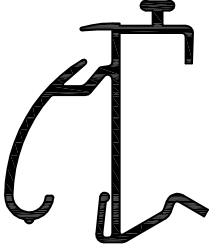
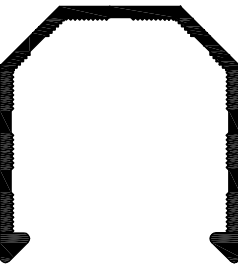
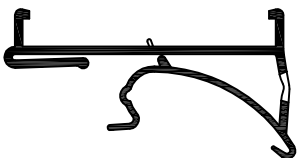

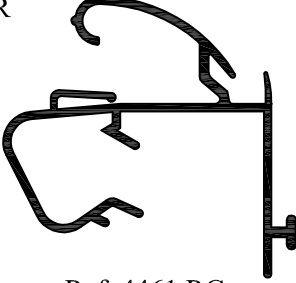
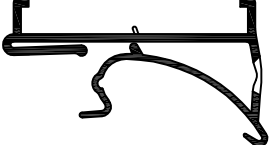

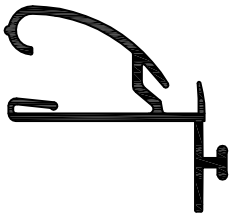

 <p>R</p>	<p>R</p>  <p>Ref. 4396 FL</p>	<p>R</p>  <p>Ref. 4397 FL</p>	
	<p>R</p>  <p>Ref. 4398 RG</p>	<p>R</p>  <p>Ref. 4399 FL</p>	
	 <p>Ref. 4400 RG+RG</p>		
	 <p>Ref. 4402 FL</p>	 <p>Ref. 4403 FL</p>	
	<p>R</p>  <p>Ref. 4404 EPDM</p>	<p>R</p>  <p>Ref. 4405 EPDM</p>	
	<p>Ref. 4392 RG</p>		

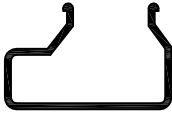
R  Ref. 4406 EPDM	R  Ref. 4407 EPDM	R  Ref. 4408 EPDM
R  Ref. 4409 FL	R  Ref. 4410 RG	 Ref. 4411 FL
R  Ref. 4412 FL	 Ref. 4413 RG+RG	 Ref. 4414 RG
 Ref. 4415 RG	R  Ref. 4416 RG	R  Ref. 4417 RG
 Ref. 4418 RG+RG	 Ref. 4419 RG+FL	R  Ref. 4420 FL

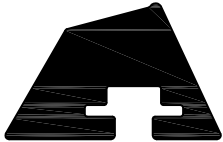
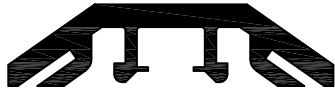



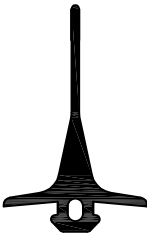
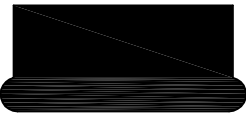

<p>R</p>  <p>Ref. 4421 FL</p>	<p>R</p>  <p>Ref. 4423 RG</p>	
<p>R</p>  <p>Ref. 4422 RG</p>	<p>R</p>  <p>Ref. 4424 RG</p>	<p>R</p>  <p>Ref. 4425 RG</p>
<p>R</p>  <p>Ref. 4426 RG</p>	<p>R</p>  <p>Ref. 4427 RG</p>	<p>R</p>  <p>Ref. 4428 FL</p>
<p>R</p>  <p>Ref. 4429 EPDM</p>	<p>R</p>  <p>Ref. 4431 RG</p>	<p>R</p>  <p>Ref. 4432 FL</p>
<p>R</p>  <p>Ref. 4433 RG</p>	<p>R</p>  <p>Ref. 4434 RG+FL</p>	<p>R</p>  <p>Ref. 4435 RG</p>



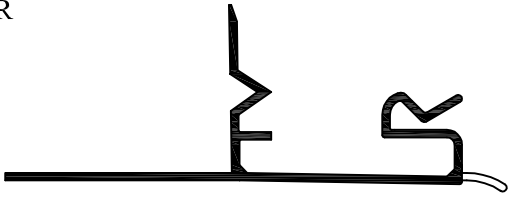
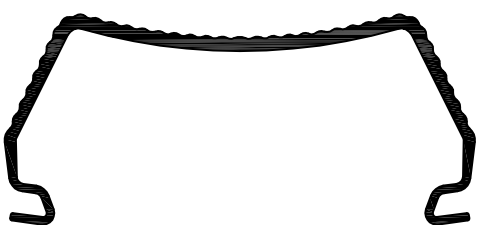

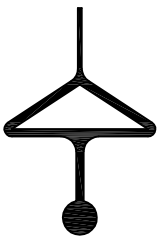

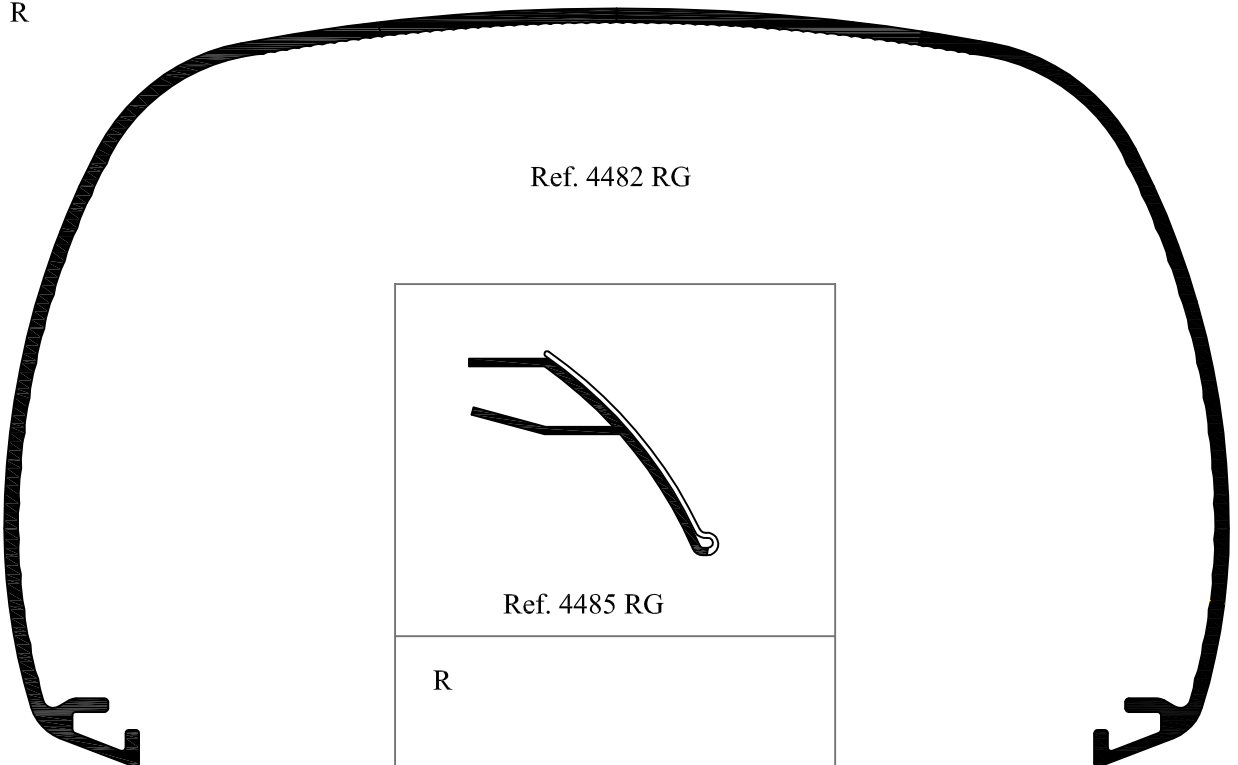
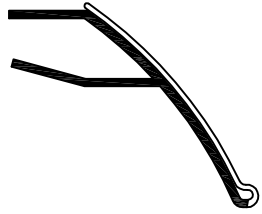

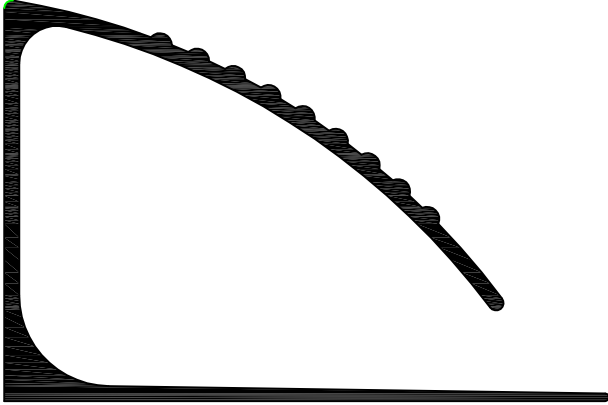
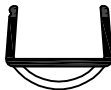

<p>R</p>  <p>Ref. 4436 RG+RG</p>	<p>R</p>  <p>Ref. 4437 RG+RG</p>	 <p>Ref. 4439 RG + FL</p>
<p>R</p>  <p>Ref. 4438 RG+RG</p>	<p>R</p>  <p>Ref. 4440 FL</p>	 <p>Ref. 4441 PC</p>
 <p>Ref. 4442 PC</p>	<p>R</p>  <p>Ref. 4443 FL</p>	<p>R</p>  <p>Ref. 4444 RG+FL</p>
<p>R</p>  <p>Ref. 4446 RG+RG</p>	<p>R</p>  <p>Ref. 4445 RG+RG</p>	
<p>R</p>  <p>Ref. 4447 RG</p>	<p>R</p>  <p>Ref. 4448 RG+RG</p>	<p>R</p>  <p>Ref. 4449 RG+RG</p>





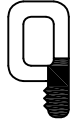





<p>R</p>  <p>Ref. 4450 FL</p>	 <p>Ref. 4451 RG</p>	 <p>Ref. 4452 RG</p>
 <p>Ref. 4454 FL</p>	<p>R</p>  <p>Ref. 4453 PC</p>	
 <p>Ref. 4455 PC</p>	 <p>Ref. 4456 EPDM</p>	
<p>R</p>  <p>Ref. 4457 RG</p>	<p>R</p>  <p>Ref. 4458 PC</p>	<p>R</p>  <p>Ref. 4459 RG+FL</p>
<p>R</p>  <p>Ref. 4460 RG</p>	<p>R</p>  <p>Ref. 4461 RG</p>	<p>R</p>  <p>Ref. 4462 RG+FL</p>

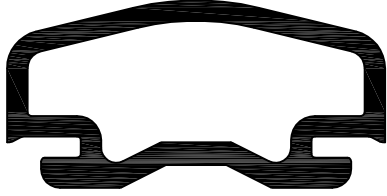



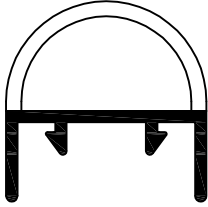



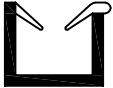
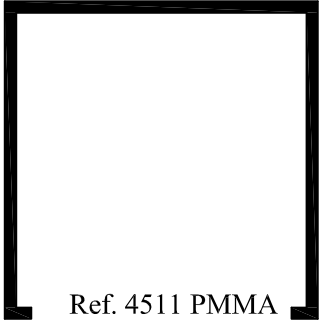

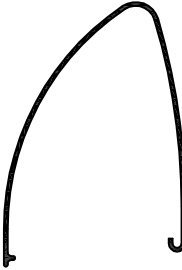

<p>R</p>  <p>Ref. 4463 RG</p>	 <p>Ref. 4464 PP</p>	<p>R</p>  <p>Ref. 4465 FL</p>
 <p>Ref. 4466 RG+FL</p>	<p>R</p>  <p>Ref. 4468 RG</p>	<p>R</p>  <p>Ref. 4469 FL</p>
<p>R</p>  <p>Ref. 4470 RG+FL</p>	 <p>Ref. 4471 RG</p>	<p>R</p>  <p>Ref. 4472 RG</p>
<p>R</p>  <p>Ref. 4473 RG</p>	 <p>Ref. 4474 RG+FL</p>	 <p>Ref. 4475 RG</p>
 <p>Ref. 4476 EPDM</p>	 <p>Ref. 4477 PP</p>	<p>R</p>  <p>Ref. 4478 RG+FL</p>





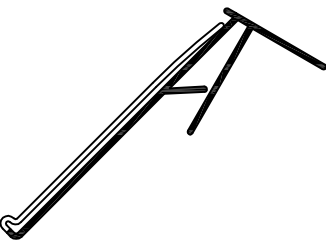









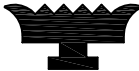
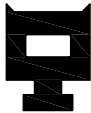

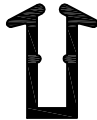

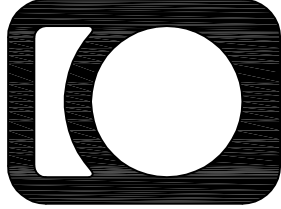
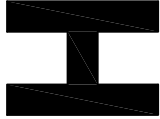

<p>R</p>  <p>Ref. 4479 RG+FL</p>	<p>R</p>  <p>Ref. 4480 PC</p>	
<p>R</p>  <p>Ref. 4481 FL</p>	<p>R</p>  <p>Ref. 4483 FL</p>	 <p>Ref. 4484 FL</p>
<p>R</p>  <p>Ref. 4482 RG</p> <div data-bbox="555 1377 997 1727">  <p>Ref. 4485 RG</p> </div> <div data-bbox="555 1727 997 2076"> <p>R</p>  <p>Ref. 4487 PC</p> </div>		

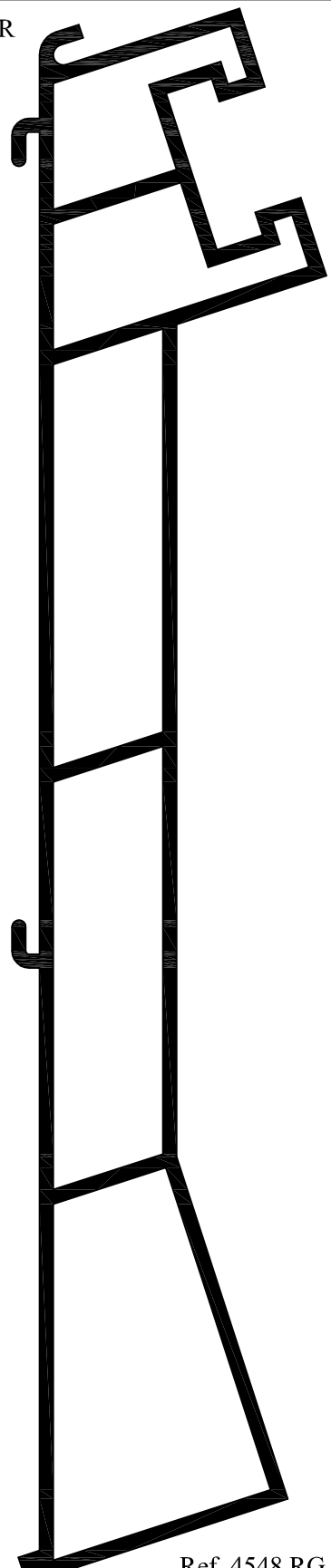



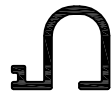
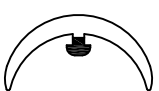

<p>R</p>  <p>Ref. 4486 FL</p>	<p>R</p>  <p>Ref. 4488 RG+FL</p> <p>R</p>  <p>Ref. 4489 RG+FL</p>	
<p>R</p>  <p>Ref. 4490 RG</p>	<p>R</p>  <p>Ref. 4491 PC</p>	
<p>R</p>  <p>Ref. 4492 FL</p>	<p>R</p>  <p>Ref. 4493 FL</p>	<p>R</p>  <p>Ref. 4494 CA + CA EXP</p>
 <p>Ref. 4495 RG+RG</p>	 <p>Ref. 4496 RG EXP</p>	 <p>Ref. 4497 RG EXP</p>

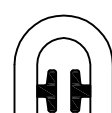
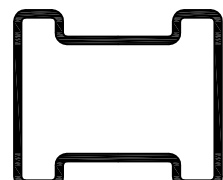



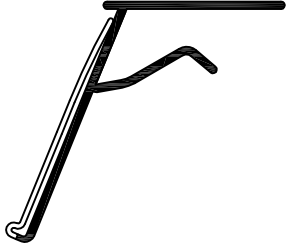
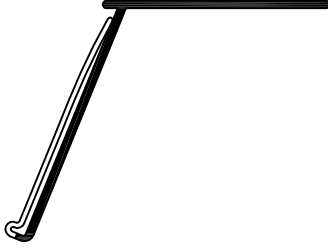

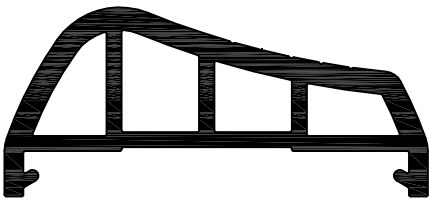

 <p>Ref. 4498 RG EXP</p>	<p>R</p>  <p>Ref. 4499 RG</p>	<p>R</p>  <p>Ref. 4500 EPDM</p>
 <p>Ref. 4501 EPDM</p>	 <p>Ref. 4502 RG+RG+FL</p>	
 <p>Ref. 4503 RG+FL</p>	 <p>Ref. 4504 RG+FL</p>	<p>R</p>  <p>Ref. 4505 RG+FL</p>
 <p>Ref. 4506 FL</p>	<p>R</p>  <p>Ref. 4507 RG</p>	 <p>Ref. 4508 FL</p>
<p>R</p>  <p>Ref. 4509 FL</p>	<p>R</p>  <p>Ref. 4510 RG+FL</p>	<p>R</p>  <p>Ref. 4511 PMMA</p>

<p>R</p>  <p>Ref. 4512 RG</p>	<p>R</p>  <p>Ref. 4513 RG</p>	<p>R</p>  <p>Ref. 4514 RG</p>
 <p>Ref. 4515 RG</p>	<p>R</p>  <p>Ref. 4516 FL</p>	 <p>Ref. 4517 RG+FL</p>
<p>R</p>  <p>Ref. 4518 FL</p>	<p>R</p>  <p>Ref. 4519 FL</p>	<p>R</p>  <p>Ref. 4520 PC</p>
 <p>Ref. 4521 RG+RG</p>	<p>R</p>  <p>Ref. 4522 PC</p>	
<p>R</p>  <p>Ref. 4523 RG+FL</p>	<p>R</p>  <p>Ref. 4524 RG+FL</p>	<p>R</p>  <p>Ref. 4525 RG</p>

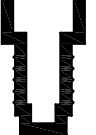
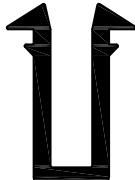



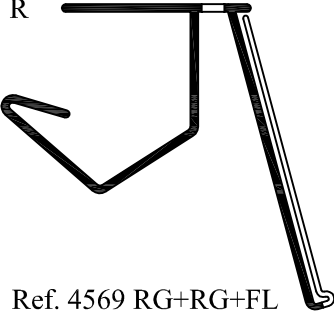
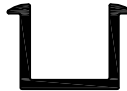





R		
		
Ref. 4526 PC		Ref. 4527 FL
R	R	
		
Ref. 4528 FL	Ref. 4529 PMMA	Ref. 4530 EPDM
	R	R
		
Ref. 4531 EPDM	Ref. 4532 FL	Ref. 4534 FL
R		
		
Ref. 4533 RG		Ref. 4535 FL
R		
		
Ref. 4536 FL	Ref. 4537 RG	Ref. 4538 RG

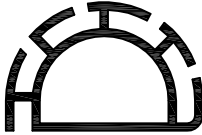



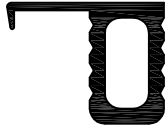

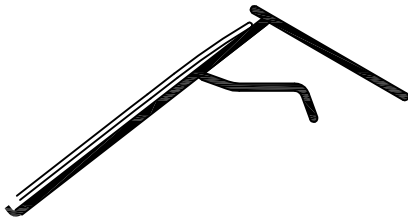

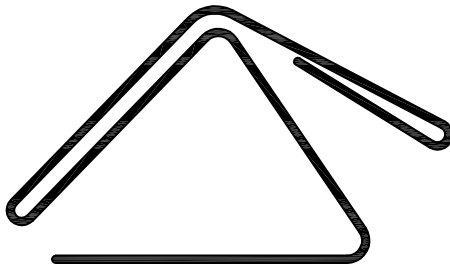

<p>R</p>  <p>Ref. 4548 RG</p>	 <p>Ref. 4539 FL</p>	 <p>Ref. 4540 RG</p>
	 <p>Ref. 4541 FL</p>	 <p>Ref. 4542 RG</p>
	 <p>Ref. 4543 RG+FL</p>	<p>R</p>  <p>Ref. 4544 PC</p>
	<p>R</p>  <p>Ref. 4545 CA+CA</p>	 <p>Ref. 4546 PC</p>
	<p>R</p>  <p>Ref. 4547 FL+FL</p>	 <p>Ref. 4549 RG</p>

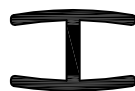





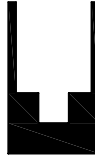

 Ref. 4550 RG	R  Ref. 4551 FL	 Ref. 4552 RG+RG
	 Ref. 4553 RG+RG	R  Ref. 4554 FL
	R  Ref. 4555 RG	R  Ref. 4556 RG
	 Ref. 4560 FL	
	R  Ref. 4557 FL	

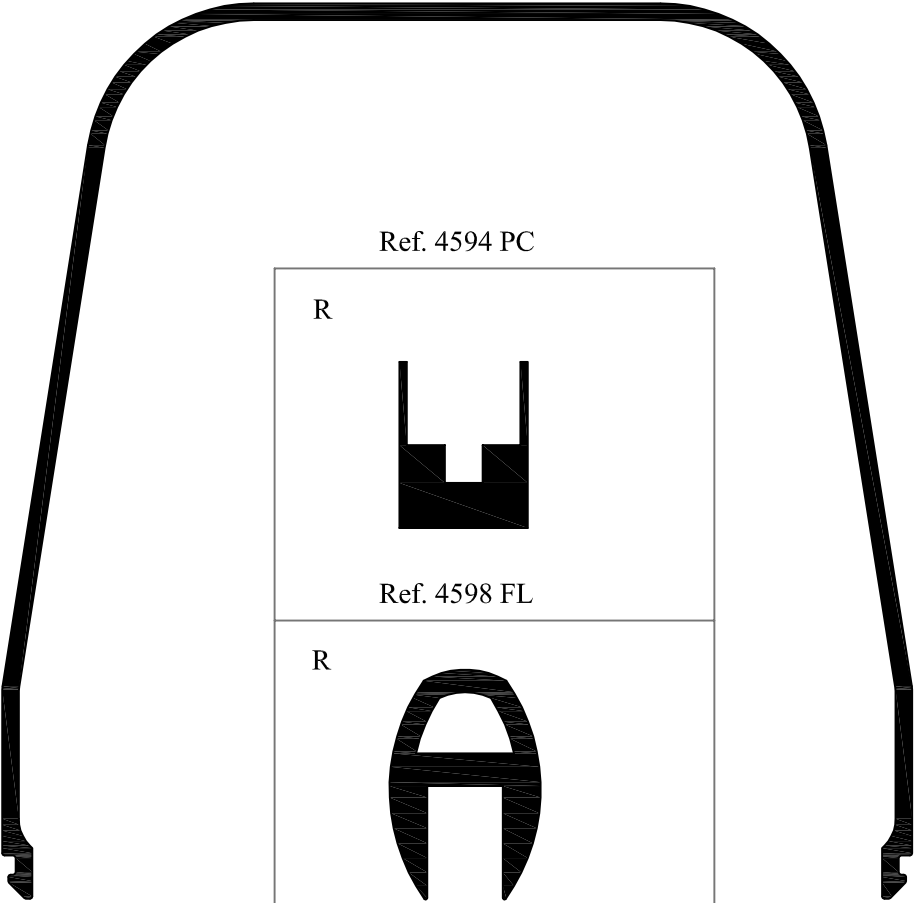
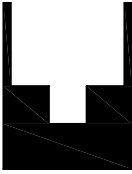





 <p>Ref. 4558 PMMA</p>		<p>R</p>  <p>Ref. 4561 FL</p>
<p>R</p>  <p>Ref. 4562 FL</p>	<p>R</p>  <p>Ref. 4563 FL</p>	<p>R</p>  <p>Ref. 4564 FL</p>
<p>R</p>  <p>Ref. 4565 RG</p>	<p>R</p>  <p>Ref. 4566 RG</p>	
<p>R</p>  <p>Ref. 4567 FL</p>	<p>R</p>  <p>Ref. 4569 RG+RG+FL</p>	<p>R</p>  <p>Ref. 4570 FL</p>
<p>R</p>  <p>Ref. 4568 RG+RG</p>		



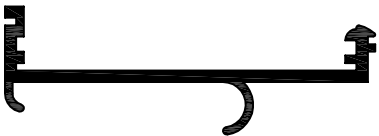

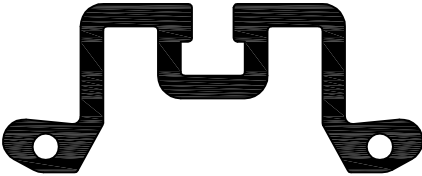

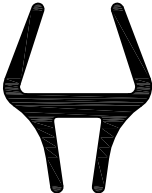
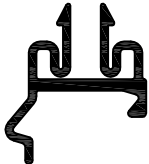
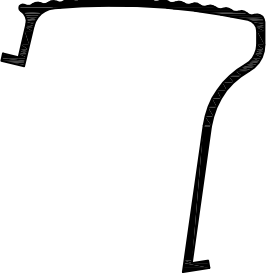
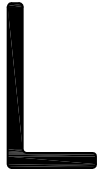
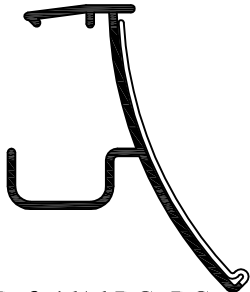
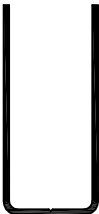
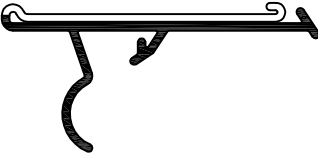



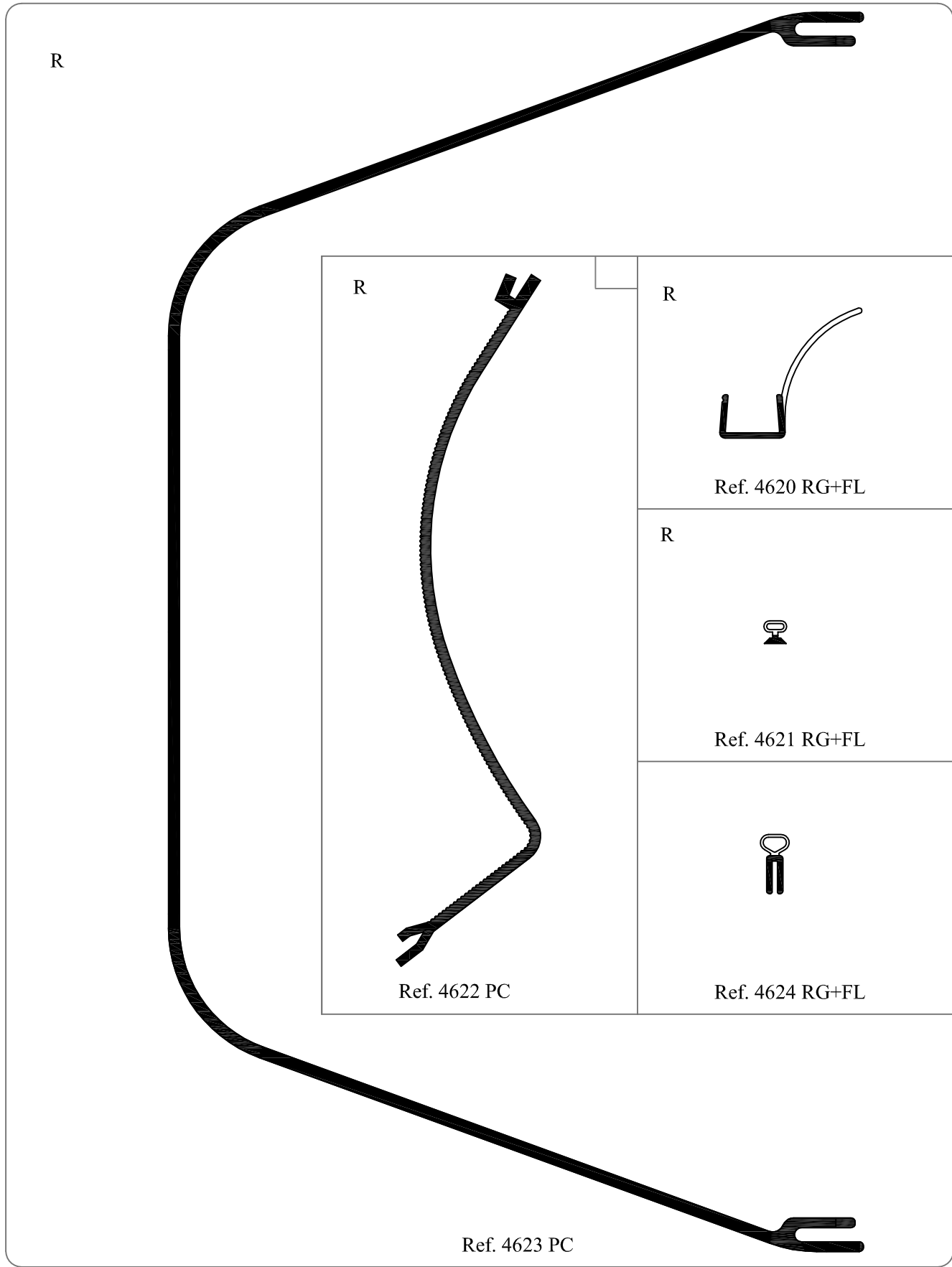

<p>R</p>  <p>Ref. 4571 FL</p>	 <p>Ref. 4573 RG</p>	<p>R</p>  <p>Ref. 4574 RG</p>
<p>R</p>  <p>Ref. 4575 RG</p>	 <p>Ref. 4576 PC</p>	
 <p>Ref. 4577 FL</p>	<p>R</p>  <p>Ref. 4578 FL</p>	
<p>R</p>  <p>Ref. 4579 FL</p>	<p>R</p>  <p>Ref. 4580 PC</p>	 <p>Ref. 4582 RG+RG</p>
<p>R</p>  <p>Ref. 4581 PC</p>	 <p>Ref. 4583 RG</p>	



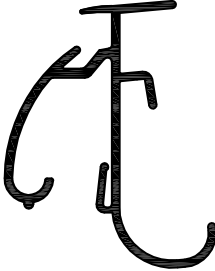
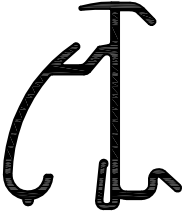



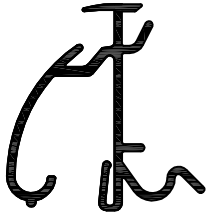

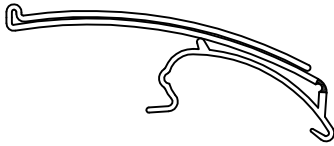
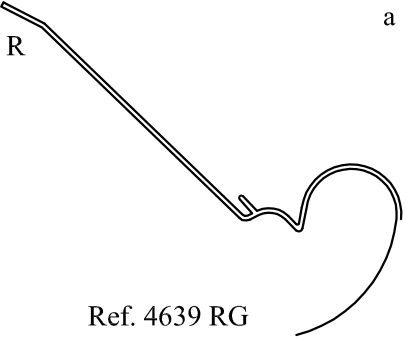

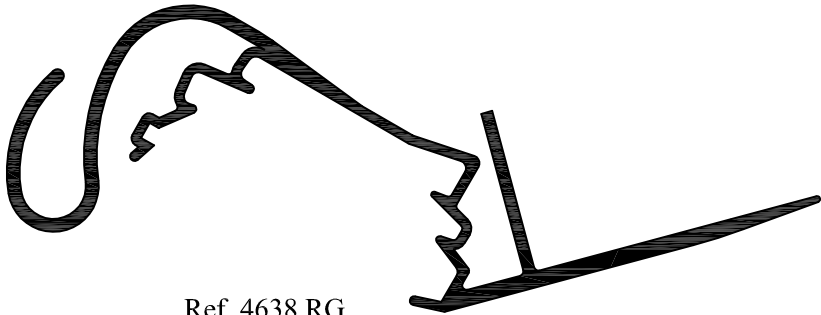
R		
		
Ref. 4584 PC		
 Ref. 4585 RG+RG	 Ref. 4586 RG	R  Ref. 4587 RG
R  Ref. 4588 RG+FL	 Ref. 4589 FL	 Ref. 4590 FL
 Ref. 4591 RG+FL	R  Ref. 4592 RG+FL	R  Ref. 4593 FL
R  Ref. 4595 FL	R  Ref. 4596 FL	R  Ref. 4597 FL

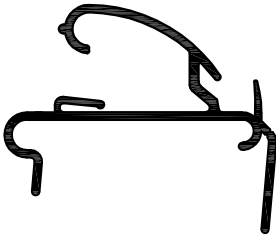
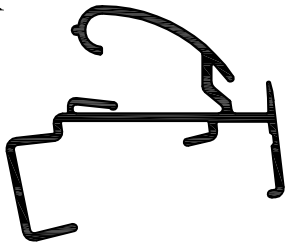

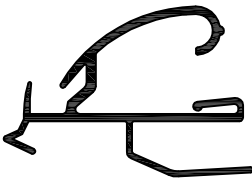

<p>R</p> 	<p>Ref. 4594 PC</p> <p>R</p>  <p>Ref. 4598 FL</p> <p>R</p>  <p>Ref. 4599 EPDM</p>	
 <p>Ref. 4600 PC</p>	<p>R</p>  <p>Ref. 4601 FL</p>	<p>R</p>  <p>Ref. 4602 RG+FL</p>
<p>R</p>  <p>Ref. 4603 RG</p>	<p>R</p>  <p>Ref. 4604 FL</p>	<p>R</p>  <p>Ref. 4605 RG+FL</p>

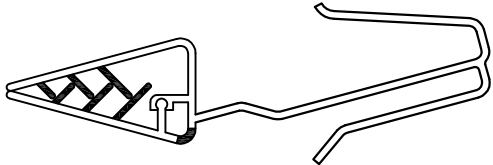
 <p>Ref. 4606 RG</p>	 <p>Ref. 4607 RG</p>	 <p>Ref. 4608 RG</p>
<p>R</p>  <p>Ref. 4609 RG</p>	<p>R</p>  <p>Ref. 4610 FL</p>	
<p>R</p>  <p>Ref. 4611 RG</p>	<p>R</p>  <p>Ref. 4612 FL</p>	<p>R</p>  <p>Ref. 4613 PC</p>
<p>R</p>  <p>Ref. 4614 PC</p>	<p>R</p>  <p>Ref. 4615 PP</p>	<p>R</p>  <p>Ref. 4616 RG+RG</p>
<p>R</p>  <p>Ref. 4617 PU</p>	<p>R</p>  <p>Ref. 4618 RG+RG</p>	<p>R</p>  <p>Ref. 4619 FL</p>



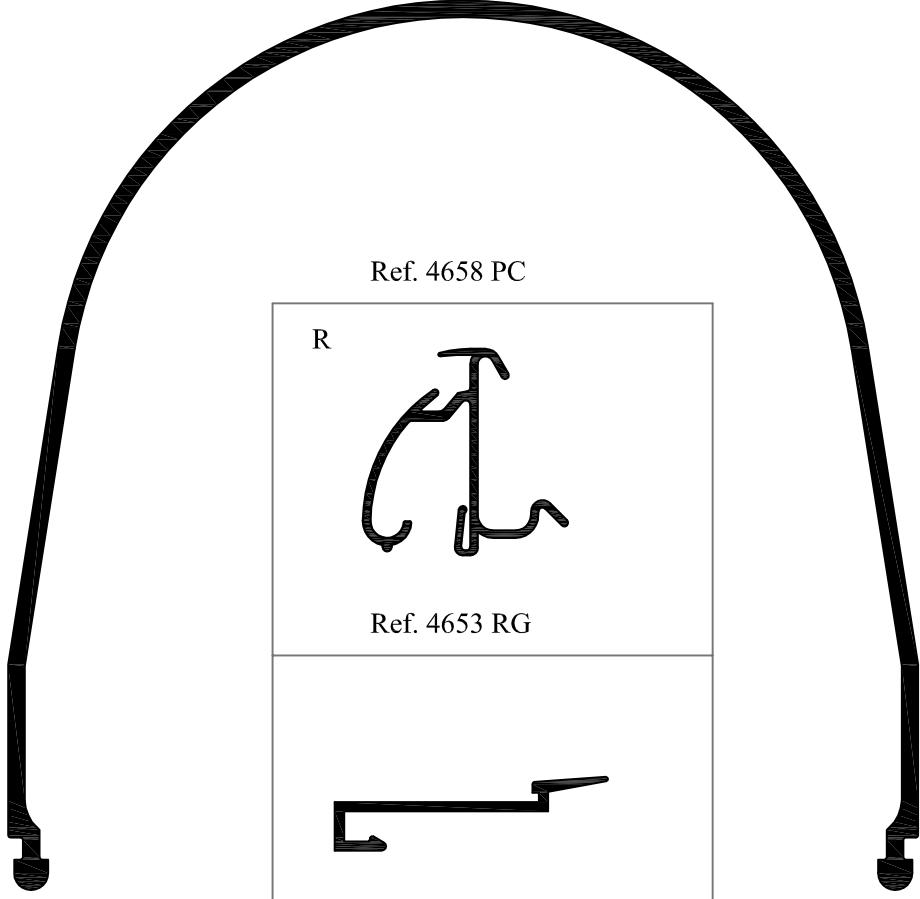
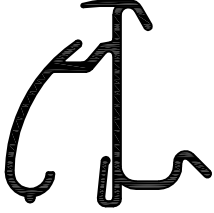

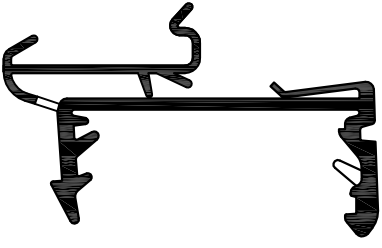
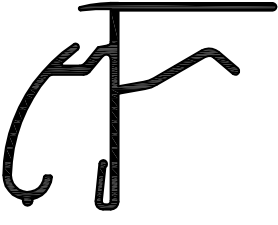

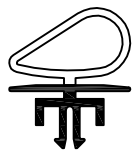



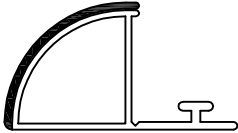

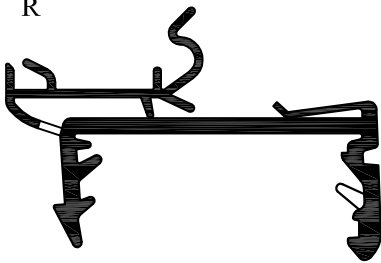
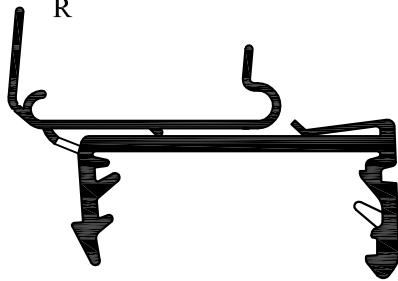
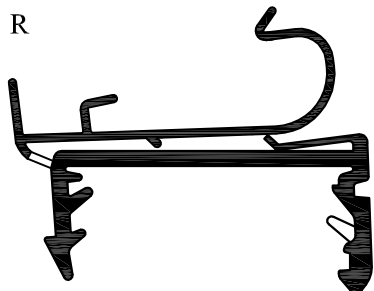
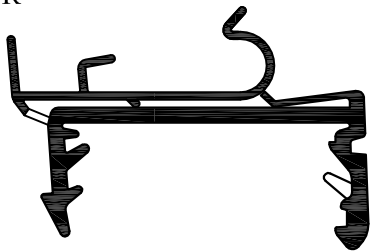
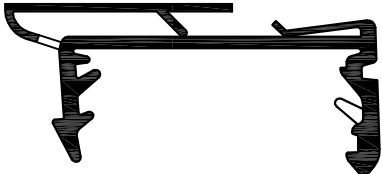







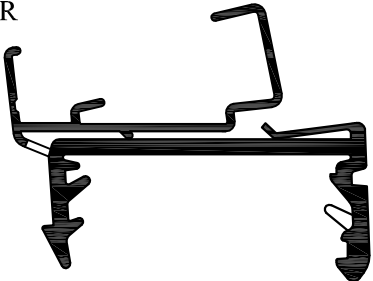
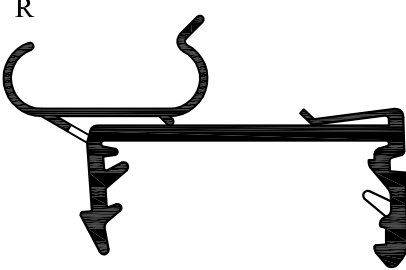

<p>R</p>  <p>Ref. 4625 RG</p>	<p>R</p>  <p>Ref. 4626 FL</p>	
<p>R</p>  <p>Ref. 4627 PC</p>	 <p>Ref. 4628 PMMA</p>	<p>R</p>  <p>Ref. 4629 RG</p>
<p>R</p>  <p>Ref. 4630 RG</p>	 <p>Ref. 4631 RG</p>	 <p>Ref. 4632 RG</p>
 <p>Ref. 4633 RG</p>	 <p>Ref. 4634 RG</p>	<p>R</p>  <p>Ref. 4635 RG</p>
 <p>Ref. 4636 RG</p>	<p>R</p>  <p>Ref. 4637 RG+FL</p>	<p>R</p>  <p>Ref. 4639 RG</p> <p>a</p>

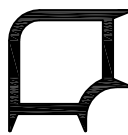

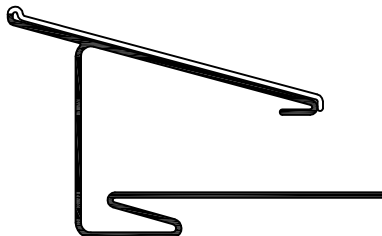
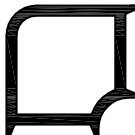

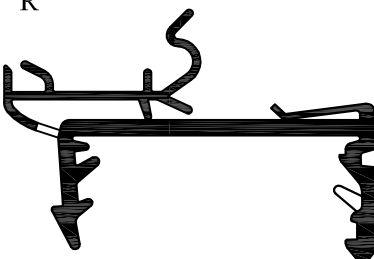

 <p>Ref. 4638 RG</p>	<p>R</p>  <p>Ref. 4640 FL</p>	
<p>R</p>  <p>Ref. 4641 FL</p>	<p>R</p>  <p>Ref. 4642 RG</p>	<p>R</p>  <p>Ref. 4643 RG</p>
<p>R</p>  <p>Ref. 4644 FL</p>	<p>R</p>  <p>Ref. 4645 RG</p>	<p>R</p>  <p>Ref. 4647 RG+FL</p>
 <p>Ref. 4648 RG</p>	<p>R</p>  <p>Ref. 4649 RG</p>	<p>R</p>  <p>Ref. 4650 RG</p>
<p>R</p>  <p>Ref. 4652 RG+FL</p>		<p>R</p>  <p>Ref. 4651 RG+FL</p>



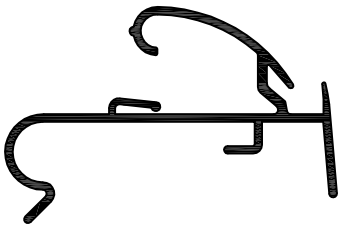
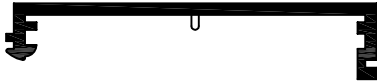
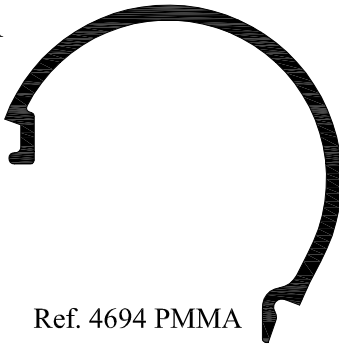

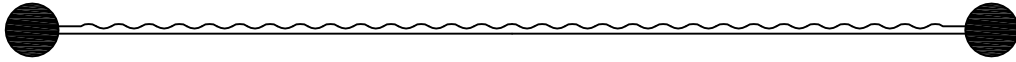
<p>R</p> 	<p>Ref. 4658 PC</p> <div data-bbox="574 683 1013 1030"> <p>R</p>  <p>Ref. 4653 RG</p> </div> <div data-bbox="574 1030 1013 1377">  </div>	
 <p>Ref. 4655 RG</p>	<p>R</p>  <p>Ref. 4656 RG+FL</p>	<p>R</p>  <p>Ref. 4657 RG</p>
<p>R</p>  <p>Ref. 4659 RG+FL</p>		<p>R</p>  <p>Ref. 4660 RG+FL</p>





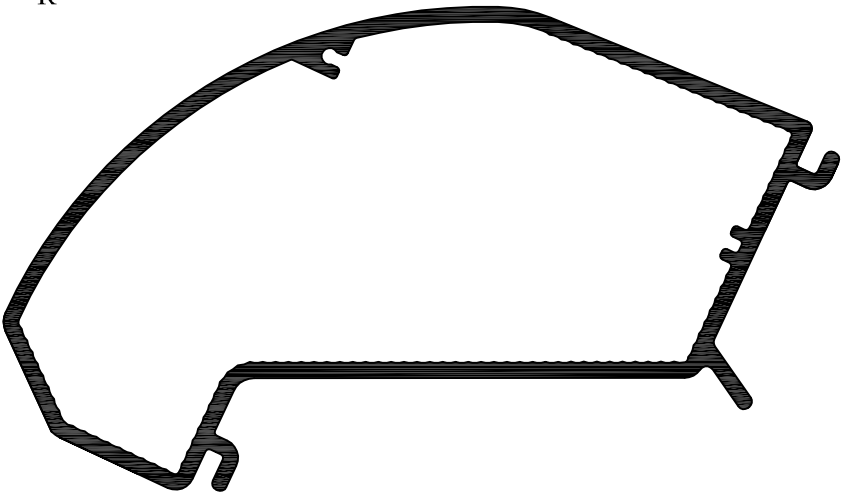

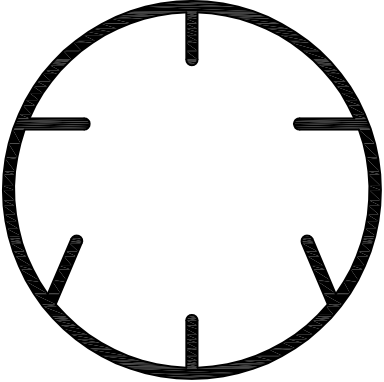
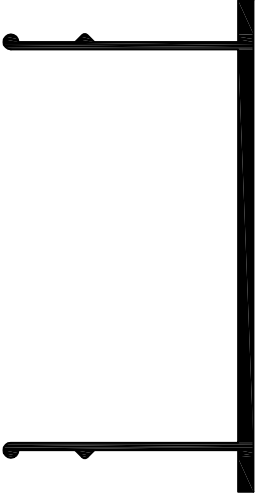

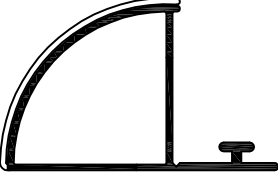









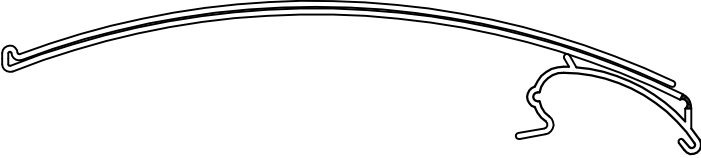

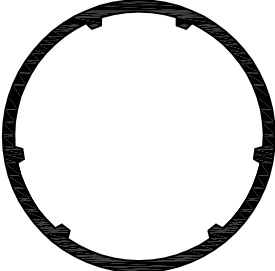
R  Ref. 4661 FL	R  Ref. 4662 RG+RG	R  Ref. 4663 RG
R  Ref. 4664 RG+FL	R  Ref. 4665 RG+FL	R  Ref. 4666 RG+FL
R  Ref. 4667 RG+FL	R  Ref. 4668 RG+FL	 Ref. 4669 FL
 Ref. 4670 FL	 Ref. 4671 RG+FL	R  Ref. 4672 FL
 Ref. 4673 EPDM	 Ref. 4674 EPDM	R  Ref. 4675 RG





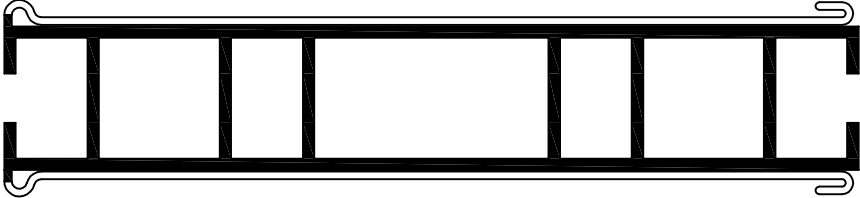
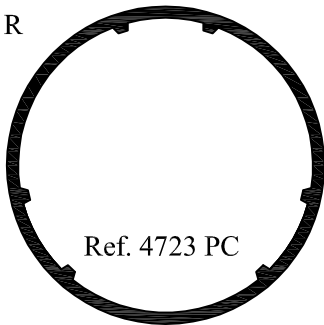
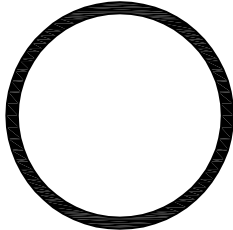
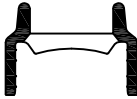

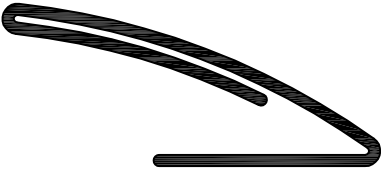
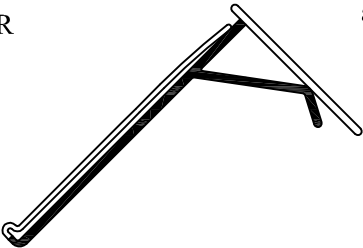
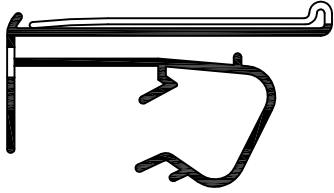

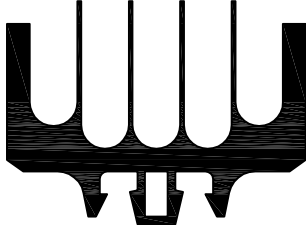
R  Ref. 4676 RG+FL	R  Ref. 4677 RG+FL	 Ref. 4678 RG+FL
R  Ref. 4679 RG	R  Ref. 4680 RG	R  Ref. 4681 RG
R  Ref. 4682 RG	R  Ref. 4683 RG+RG	R  Ref. 4684 RG
R  Ref. 4685 RG	R  Ref. 4686 RG	R  Ref. 4687 RG+FL
R  Ref. 4688 PMMA	R  Ref. 4690 FL	R  Ref. 4691 RG



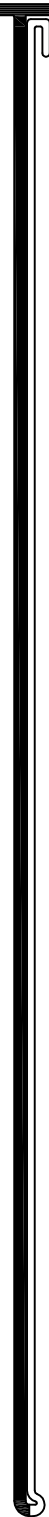



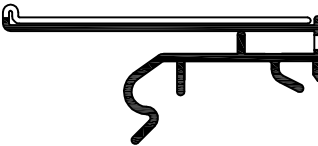
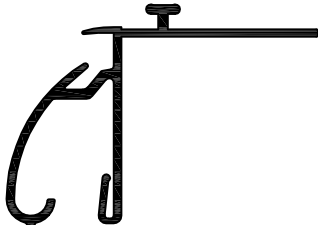
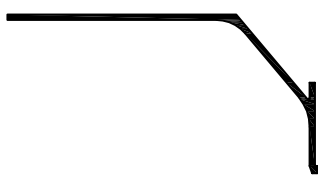

<p>R</p>  <p>Ref. 4689 PMMA E 1/2</p>		
<p>R</p>  <p>Ref. 4692 RG</p>	 <p>Ref. 4693 RG+FL</p>	<p>R</p>  <p>Ref. 4694 PMMA</p>
 <p>Ref. 4695 PC</p>		<p>R</p>  <p>Ref. 4698 RG</p>
<p>R</p>  <p>Ref. 4696 RG+RG</p>		
<p>R</p>  <p>Ref. 4699 FL</p>	<p>R</p>  <p>Ref. 4700 FL</p>	 <p>Ref. 4701 RG</p>

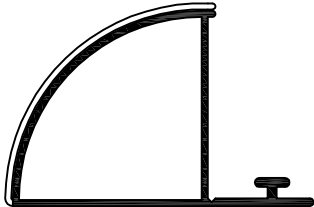
<p>R</p>  <p>Ref. 4697 PC</p>		<p>R</p>  <p>Ref. 4703 PC</p>
<p>R</p>  <p>Ref. 4704 RG</p>	<p>R</p>  <p>Ref. 4705 PC</p>	
<p>R</p>  <p>Ref. 4702 PC</p>	<p>R</p>  <p>Ref. 4707 RG+RG</p>	

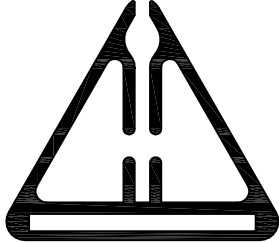
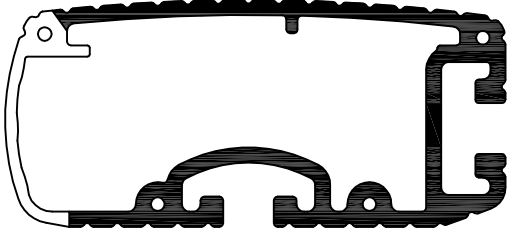

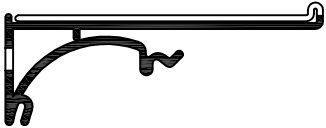

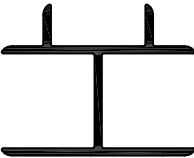

<p>R</p>  <p>Ref. 4706 PC</p>	<p>R</p>  <p>Ref. 4708 PC</p>	
<p>R</p>  <p>Ref. 4709 FL</p>	 <p>Ref. 4710 FL</p>	 <p>Ref. 4711 FL</p>
 <p>Ref. 4712 FL</p>	 <p>Ref. 4713 RG</p>	 <p>Ref. 4714 RG</p>
<p>R</p>  <p>Ref. 4715 RG+FL</p>		 <p>Ref. 4716 RG+FL</p>
<p>R</p>  <p>Ref. 4717 RG+FL</p>	<p>R</p>  <p>Ref. 4719 PC</p>	 <p>Ref. 4720 RG+FL</p>





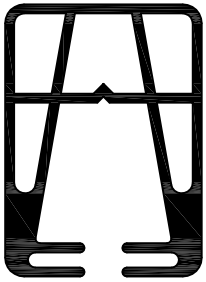
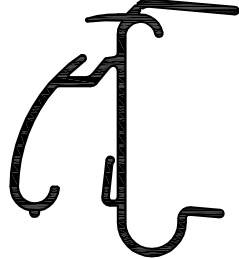

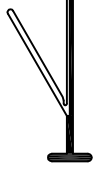
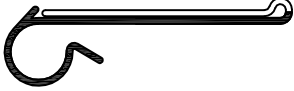

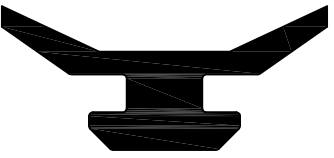

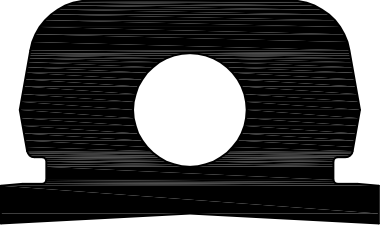

<p>R</p>  <p>Ref. 4718 RG+RG</p>			<p>R</p>  <p>Ref. 4721 PC</p>
<p>R</p>  <p>Ref. 4722 RG+RG</p>			<p>R</p>  <p>Ref. 4723 PC</p>
<p>R</p>  <p>Ref. 4724 PC</p>	<p>R</p>  <p>Ref. 4725 PMMA+PMMA</p>	<p>R</p>  <p>Ref. 4726 FL</p>	
<p>R</p>  <p>Ref. 4727 RG</p>	<p>R</p>  <p>Ref. 4728 RG+RG+RG</p>	<p>R</p>  <p>Ref. 4730 RG+RG+FL</p>	
<p>R</p>  <p>Ref. 4731 RG</p>	<p>R</p>  <p>Ref. 4732 RG+FL</p>	<p>R</p>  <p>Ref. 4733 FL</p>	





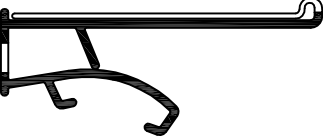

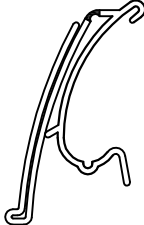

 Ref. 4734 RG+FL	R 	
 Ref. 4735 RG+FL	R  Ref. 4736 RG+FL	
R  Ref. 4737 FL	R  Ref. 4738 RG+RG+FL	
R  Ref. 4739 RG	 Ref. 4740 RG	
 Ref. 4742 RG+FL	 Ref. 4743 FL	







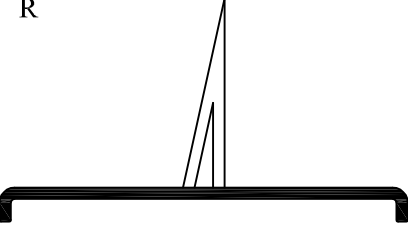



<p>R</p>  <p>Ref. 4741 RG+RG</p>	<p>R</p>  <p>Ref. 4744 RG+RG</p>	
<p>R</p>  <p>Ref. 4745 FL</p>	 <p>Ref. 4746 RG</p>	 <p>Ref. 4747 RG</p>
<p>R</p>  <p>Ref. 4748 PC+PC</p>		<p>R</p>  <p>Ref. 4749 FL</p>
 <p>Ref. 4750 RG</p>	<p>R</p>  <p>Ref. 4751 RG+RG+FL</p>	 <p>Ref. 4752 FL</p>
 <p>Ref. 4753 RG</p>	 <p>Ref. 4754 RG</p>	<p>R</p>  <p>Ref. 4755 RG</p>



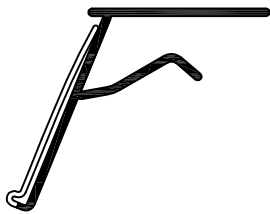

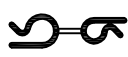





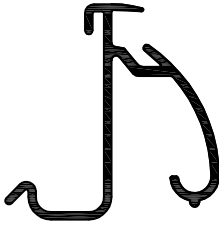









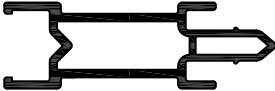



<p>R</p> 	 <p>Ref. 4756 RG</p>	 <p>Ref. 4757 RG</p>	
	 <p>Ref. 4758 RG</p>	<p>R</p>  <p>Ref. 4759 RG</p>	
	 <p>Ref. 4761 FL</p>	 <p>Ref. 4762 RG+FL</p>	
	 <p>Ref. 4763 RG+RG</p>	 <p>Ref. 4764 FL</p>	
	<p>R</p>  <p>Ref. 4765 RG+FL</p>	<p>R</p>  <p>Ref. 4766 EPDM</p>	
	<p>Ref. 4760 RG    E 1/3</p>		

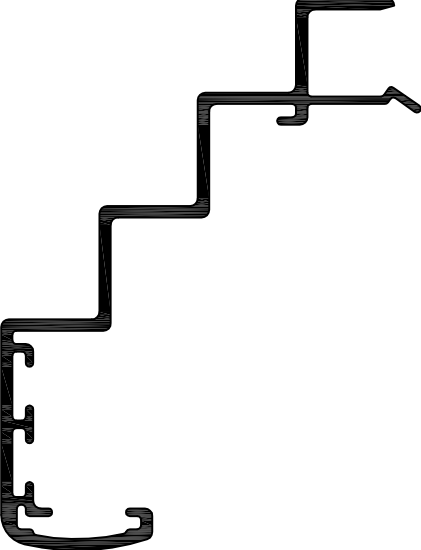

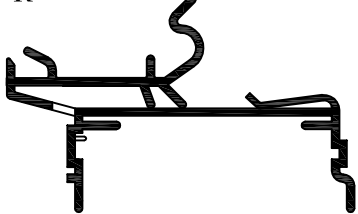
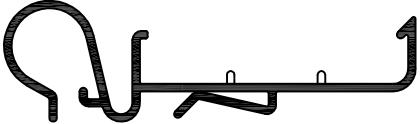



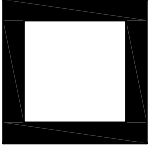

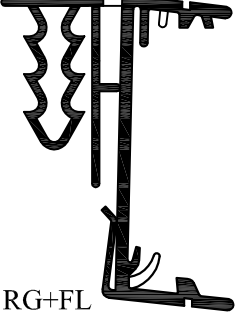
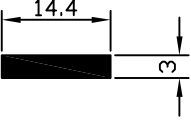

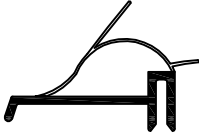
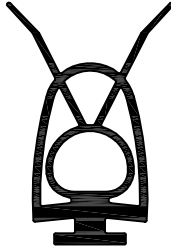
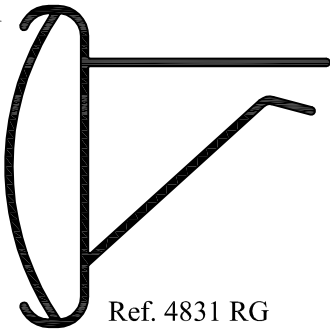
<p>R</p>  <p>Ref. 4767 EPDM</p>	<p>R</p>  <p>Ref. 4768 EPDM</p>	 <p>Ref. 4769 RG</p>
<p>R</p>  <p>Ref. 4771 RG</p>	 <p>Ref. 4770 RG</p>	
<p>R</p>  <p>Ref. 4772 FL</p>	<p>R</p>  <p>Ref. 4773 PC</p>	<p>R</p>  <p>Ref. 4774 RG+FL</p>
<p>R</p>  <p>Ref. 4775 RG+RG</p>	<p>R</p>  <p>Ref. 4776 RG+RG+FL</p>	<p>R</p>  <p>Ref. 4777 RG</p>
<p>R</p>  <p>Ref. 4778 PMMA</p>	 <p>Ref. 4779 RG+FL</p>	<p>R</p>  <p>Ref. 4781 RG+FL</p>



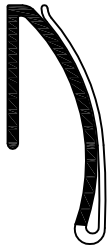

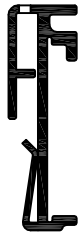



<p>R</p>  <p>Ref. 4780 RG+FL</p>	
<p>R</p>  <p>Ref. 4782 FL</p>	 <p>Ref. 4784 FL</p>
<p>R</p>  <p>Ref. 4783 PC</p>	<p>R</p>  <p>Ref. 4785 RG</p>
 <p>Ref. 4787 RG</p>	<p>R</p>  <p>Ref. 4786 PC</p>
<p>R</p>  <p>Ref. 4790 RG+FL</p>	<p>R</p>  <p>Ref. 4788 PMMA</p>

 <p>Ref. 4792 RG+RG</p>	 <p>Ref. 4789 RG+RG</p>	
	<p>R</p>  <p>Ref. 4791 RG+FL</p>	<p>R</p>  <p>Ref. 4793 RG+FL</p>
	 <p>Ref. 4794 RG+RG</p>	<p>R</p>  <p>Ref. 4795 RG</p>
	<p>R</p>  <p>Ref. 4796 RG+FL</p>	 <p>Ref. 4797 RG+FL</p>
	<p>R</p>  <p>Ref. 4798 RG+FL</p>	<p>R</p>  <p>Ref. 4799 RG</p>

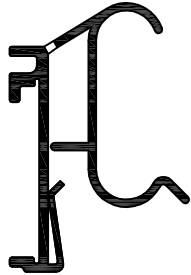
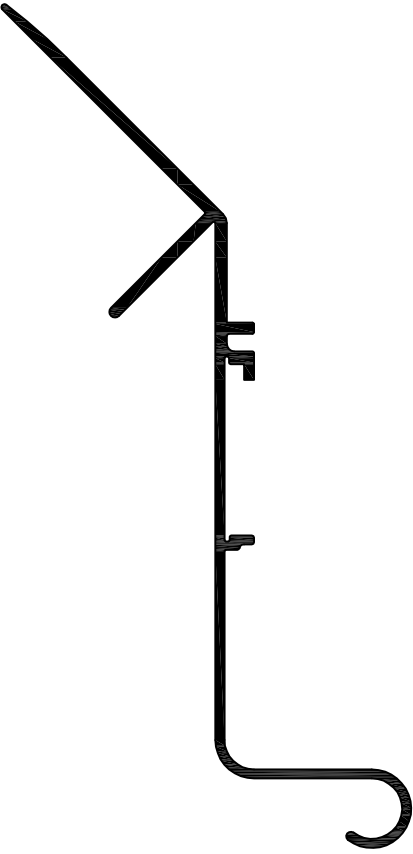

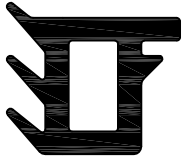
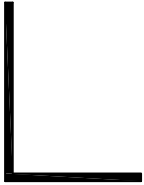

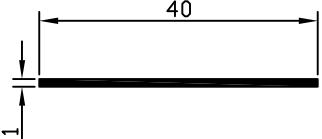



 Ref. 4800 FL	R  Ref. 4801 RG	R  Ref. 4802 RG
 Ref. 4803 RG	R  Ref. 4804 RG	R  Ref. 4805 RG
R  Ref. 4806 RG	R  Ref. 4807 RG	R  Ref. 4808 RG
R  Ref. 4809 RG	R  Ref. 4810 FL	R  Ref. 4811 RG
R  Ref. 4812 RG	R  Ref. 4813 RG	R  Ref. 4815 RG



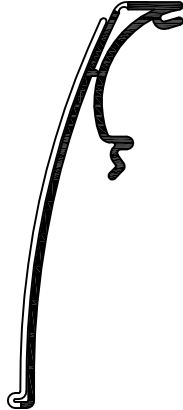
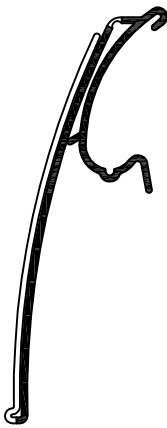

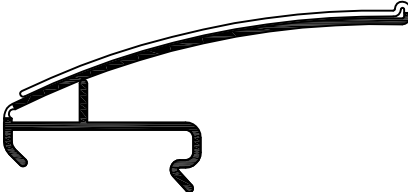

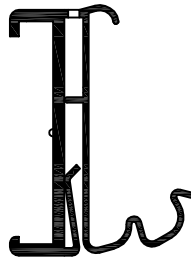

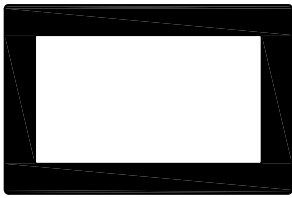
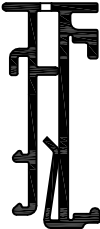

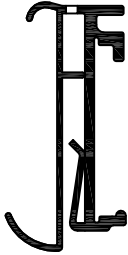



<p>R</p>  <p>Ref. 4814 RG</p>	<p>R</p>  <p>Ref. 4816 RG</p>	<p>R</p>  <p>Ref. 4817 RG+FL</p>
	<p>R</p>  <p>Ref. 4818 RG+FL</p>	<p>R</p>  <p>Ref. 4819 RG+FL</p>
<p>R</p>  <p>Ref. 4820 FL</p>	<p>R</p>  <p>Ref. 4821 RG+FL</p>	<p>R</p>  <p>Ref. 4822 PC</p>
<p>R</p>  <p>Ref. 4823 FL</p>	<p>R</p>  <p>Ref. 4824 FL</p>	<p>R</p>  <p>Ref. 4825 RG</p>
<p>R</p>  <p>Ref. 4826 RG+RG</p>	<p>R</p>  <p>Ref. 4827 RG+FL</p>	<p>R</p>  <p>Ref. 4828 FL</p>



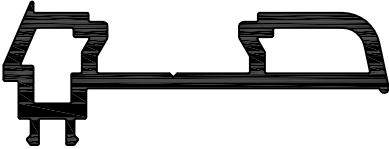





R  Ref. 4829 RG+FL	 Ref. 4830 FL	R  Ref. 4831 RG
R  Ref. 4832 FL	R  Ref. 4833 PC	R  Ref. 4834 RG
R  Ref. 4835 RG	R  Ref. 4836 RG+RG	R  Ref. 4837 FL
R  Ref. 4838 RG	R  Ref. 4839 RG+FL	R  Ref. 4840 PC
R  Ref. 4841 RG	 Ref. 4842 FL	R  Ref. 4843 RG

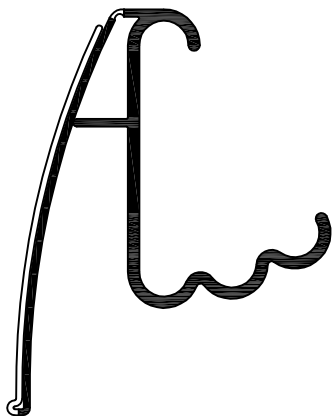
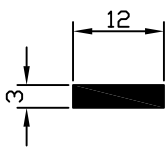



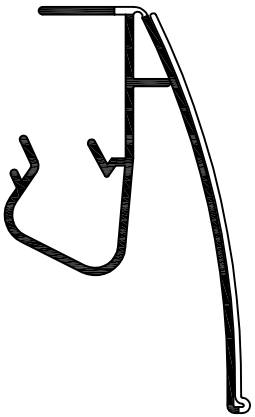
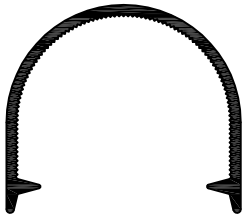

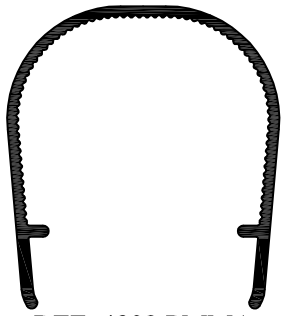

 <p>Ref. 4844 FL</p>	<p>R</p>  <p>Ref. 4845 RG+FL</p>	<p>R</p>  <p>Ref. 4846 RG+FL</p>
<p>R</p>  <p>Ref. 4847 RG</p>	<p>R</p>  <p>Ref. 4848 PP+CA</p>	<p>R</p>  <p>Ref. 4849 CA</p>
	<p>R</p>  <p>Ref. 4850 CA</p>	<p>R</p>  <p>Ref. 4851 CA</p>
	<p>R</p>  <p>Ref. 4852 CA</p>	 <p>Ref. 4853 FL</p>
 <p>Ref. 4854 RG</p>	<p>R</p>  <p>Ref. 4856 PC</p>	

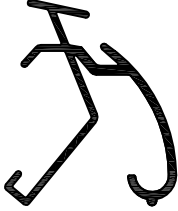

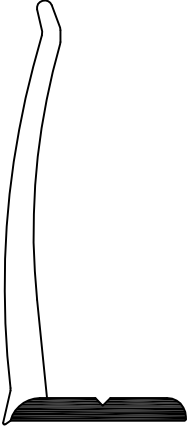

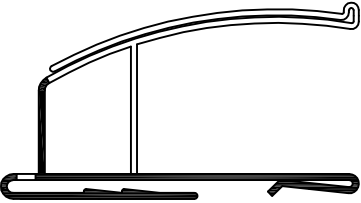
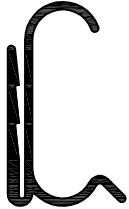



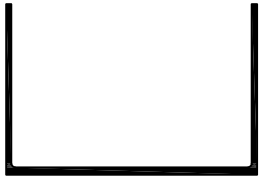

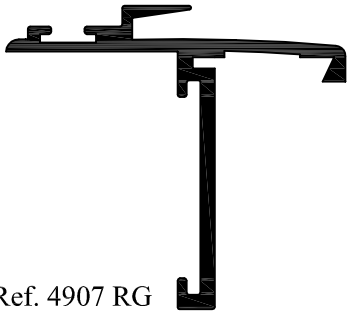

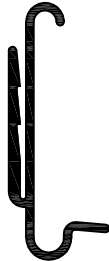
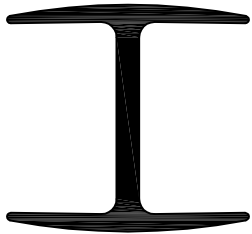

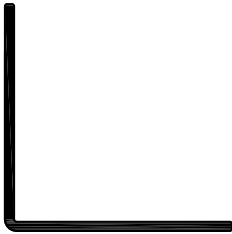
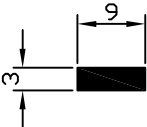



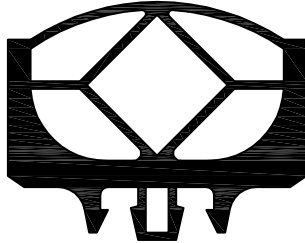
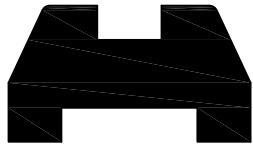
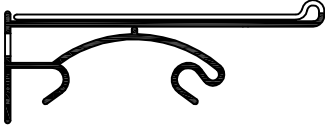

<p>R</p>  <p>Ref. 4855 RG+RG</p>	<p>R</p>  <p>Ref. 4857 RG+FL</p>	<p>R</p>  <p>Ref. 4858 RG+FL</p>
<p>R</p>  <p>Ref. 4860 RG+RG+FL</p>	<p>R</p>  <p>Ref. 4861 RG+RG+FL</p>	<p>R</p>  <p>Ref. 4859 FL</p>
<p>R</p>  <p>Ref. 4863 RG+RG+FL</p>	<p>R</p>  <p>Ref. 4864 RG+RG+FL</p>	<p>R</p>  <p>Ref. 4862 RG+FL</p>
<p>R</p>  <p>Ref. 4866 RG</p>	<p>R</p>  <p>Ref. 4867 FL</p>	<p>R</p>  <p>Ref. 4868 RG+FL</p>

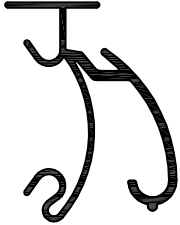



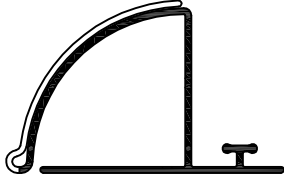
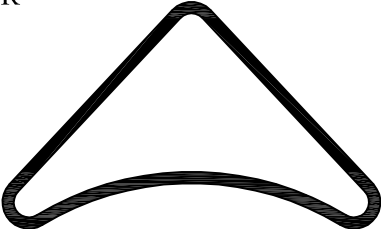

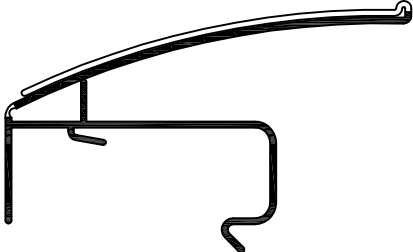
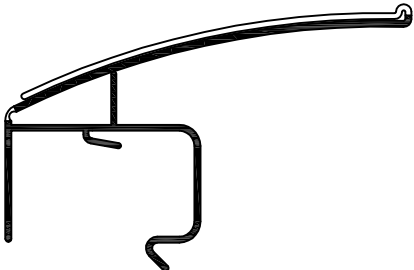



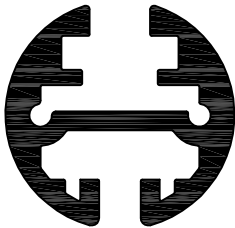

R  Ref. 4869 RG+RG+FL	R  Ref. 4870 RG+FL	R  Ref. 4871 PC
R  Ref. 4872 FL	R  Ref. 4873 PMMA	R  Ref. 4874 FL
 Ref. 4875 FL	R  Ref. 4876 RG	R  Ref. 4877 RG+FL
 Ref. 4878 RG	R  Ref. 4879 RG	R  Ref. 4880 RG
R  Ref. 4881 FL	R  REF. 4882 RG+PU	R  REF. 4884 RG





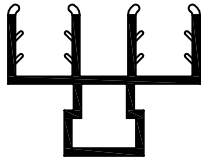



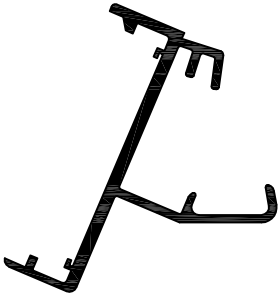

R 	 REF. 4885 FL	 REF. 4886 FL
	 REF. 4887 PC	R  REF. 4888 FL
R 	 REF. 4890 PMMA	 REF. 4891 PMMA
	 REF. 4892 PMMA	R  REF. 4893 CA+CA
R 	Ref. 4894 RG+FL	

<p>R</p>  <p>REF. 4895 RG</p>	<p>R</p>  <p>Ref. 4896 RG+RG+FL</p>	
<p>R</p>  <p>Ref. 4898 RG+FL</p>	<p>R</p>  <p>Ref. 4897 FL</p>	 <p>Ref. 4899 RG</p>
<p>R</p>  <p>Ref. 4902 RG+RG+FL</p>	<p>R</p>  <p>Ref. 4903 RG</p>	<p>R</p>  <p>Ref. 4901 FL</p>
<p>R</p>  <p>Ref. 4904 RG+FL</p>	 <p>Ref. 4905 RG+FL</p>  <p>Ref. 4906 RG</p>	



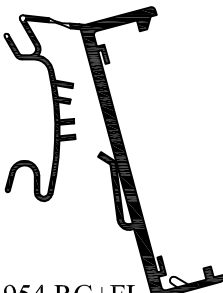



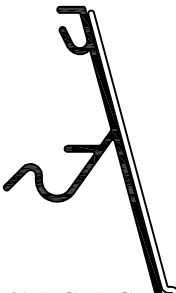

 Ref. 4907 RG	R  Ref. 4908 FL	R  Ref. 4909 RG
R  Ref. 4910 FL	R  Ref. 4911 FL	 Ref. 4912 RG
 Ref. 4913 FL	R  Ref. 4914 RG+FL	R  Ref. 4915 RG
R  Ref. 4916 RG+FL		R  Ref. 4917 FL
 Ref. 4918 RG	R  Ref. 4919 RG+RG+FL	R  Ref. 4920 RG+RG+FL

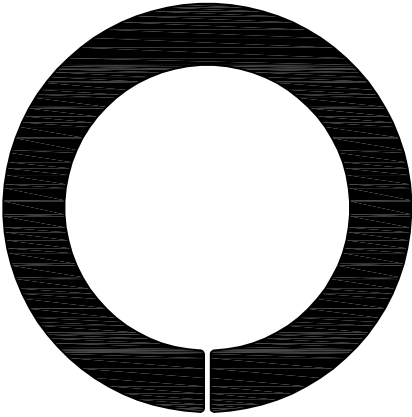
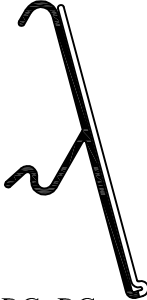
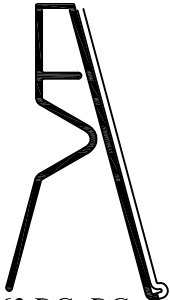

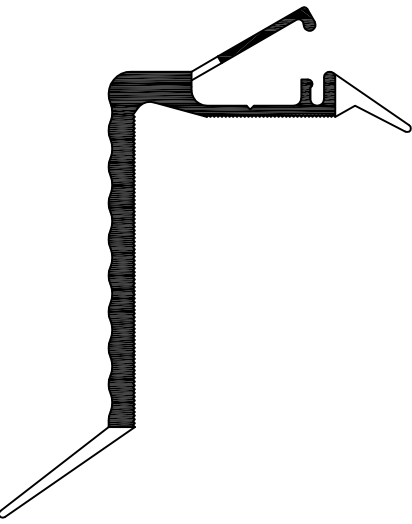

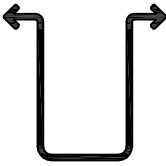

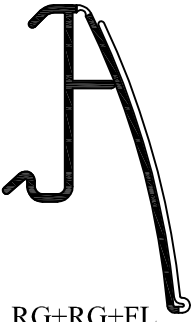
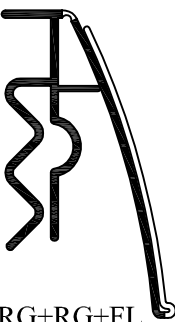



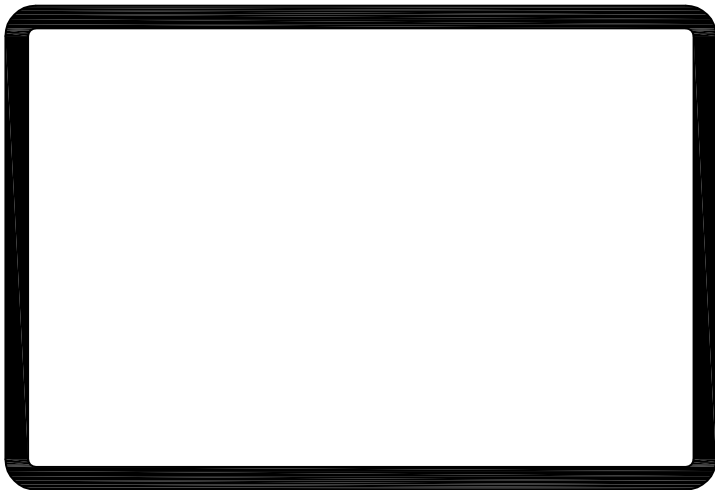

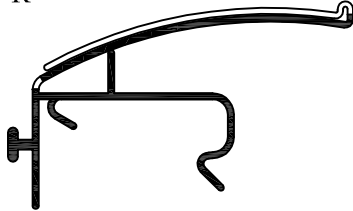
<p>R</p>  <p>Ref. 4921 RG</p>	<p>R</p>  <p>Ref. 4922 RG</p>	
<p>R</p>  <p>Ref. 4923 PMMA</p>	<p>R</p>  <p>Ref. 4924 PC</p>	 <p>Ref. 4925 RG+RG</p>
<p>R</p>  <p>Ref. 4926 RG</p>	<p>R</p>  <p>Ref. 4927 PC</p>	<p>R</p>  <p>Ref. 4928 PC</p>
<p>R</p>  <p>Ref. 4930 RG+RG+FL</p>		<p>R</p>  <p>Ref. 4931 RG+RG+FL</p>
<p>R</p>  <p>Ref. 4929 RG</p>	<p>R</p>  <p>Ref. 4932 RG+RG+FL</p>	

 Ref. 4933 PC	 Ref. 4934 PC	 Ref. 4935 RG
R  Ref. 4936 PC	R  Ref. 4938 RG+RG+FL	
R  Ref. 4937 PC	R  Ref. 4939 RG+RG	R  Ref. 4940 PMMA
R  Ref. 4941 PMMA	R  Ref. 4942 RG+FL	R  Ref. 4943 RG
R  Ref. 4944 FL	R  Ref. 4945 FL	R  Ref. 4946 FL









R  Ref. 4947 RG+FL	R  Ref. 4948 RG	R  Ref. 4949 PMMA
R  Ref. 4950 RG	R  Ref. 4951 PC	R  Ref. 4952 EPDM
R  Ref. 4955 PC	R  Ref. 4953 FL	R  Ref. 4954 RG+FL
	R  Ref. 4956 FL	R  Ref. 4957 RG+RG
R  Ref. 4958 RG+FL	R  Ref. 4959 RG	R  Ref. 4961 RG+RG

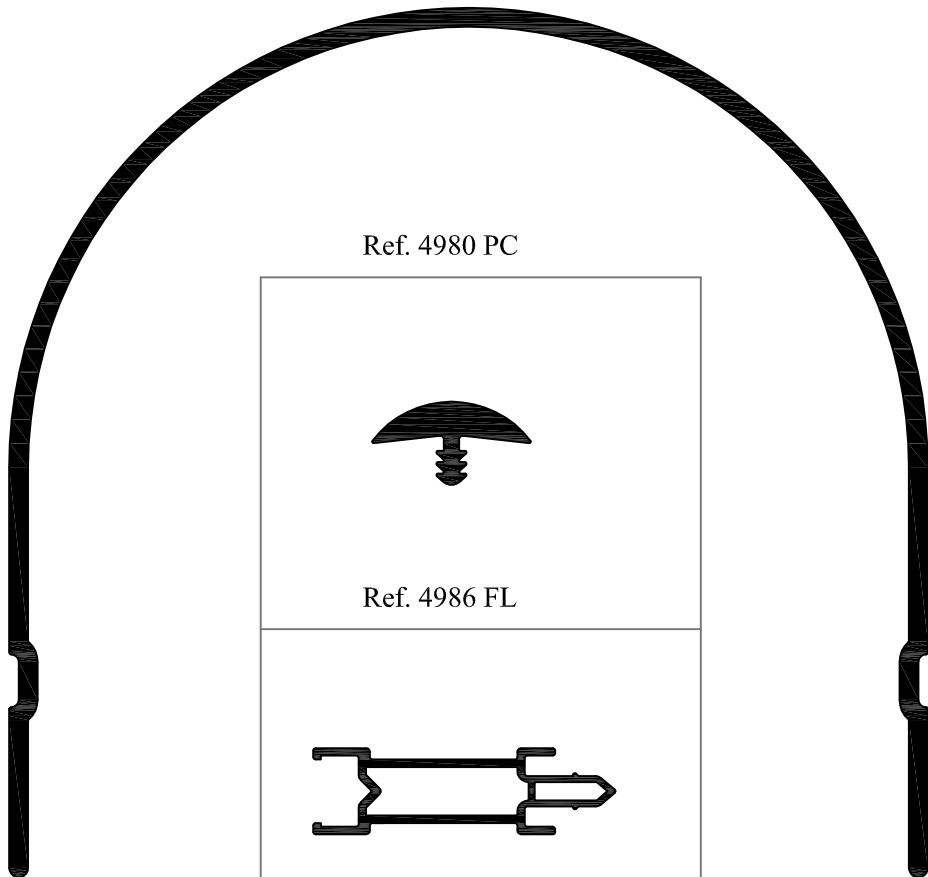











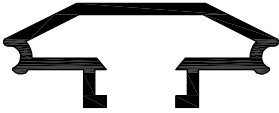

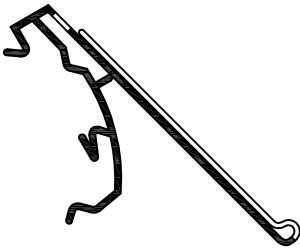
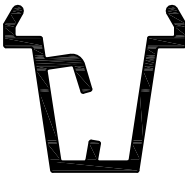





<p>R</p>  <p>Ref. 4960 FL</p>	 <p>Ref. 4962 RG+RG</p>	 <p>Ref. 4963 RG+RG</p>
 <p>Ref. 4966 RG+RG+FL</p>		
<p>R</p>  <p>Ref. 4965 RG+FL</p>	<p>R</p>  <p>Ref. 4964 FL</p>	<p>R</p>  <p>Ref. 4967 PUR</p>
<p>R</p>  <p>Ref. 4968 PC</p>		
 <p>Ref. 4969 RG</p>		
<p>R</p>  <p>Ref. 4971 RG+RG+FL</p>	<p>R</p>  <p>Ref. 4972 RG+RG+FL</p>	<p>R</p>  <p>Ref. 4973 PMMA</p>

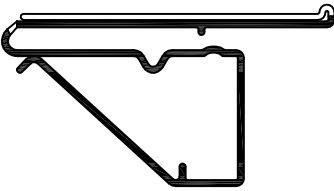



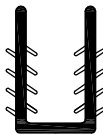

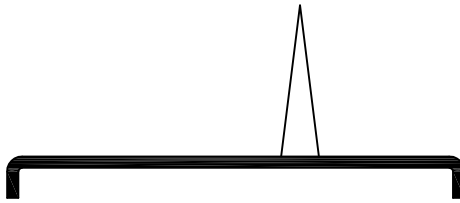

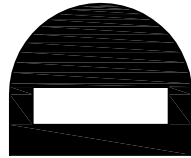

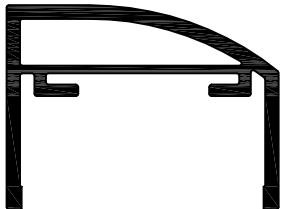
 <p>Ref. 4970 RG</p>		<p>R</p>  <p>Ref. 4974 RG+PU</p>
		<p>R</p>  <p>Ref. 4975 RG+RG+PU</p>
<p>R</p>  <p>Ref. 4976 PC</p>	 <p>Ref. 4977 RG</p>	<p>R</p>  <p>Ref. 4978 FL</p>
<p>R</p>  <p>Ref. 4979 RG+FL</p>	<p>R</p>  <p>Ref. 4981 PC</p>	<p>R</p>  <p>Ref. 4982 PC</p>
<p>R</p>  <p>Ref. 4983 PC</p>	<p>R</p>  <p>Ref. 4984 RG</p>	<p>R</p>  <p>Ref. 4985 PC</p>

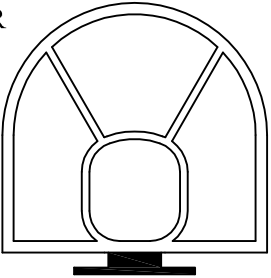



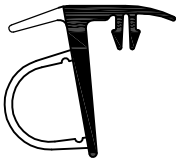

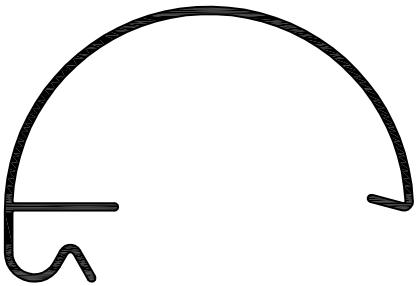
R

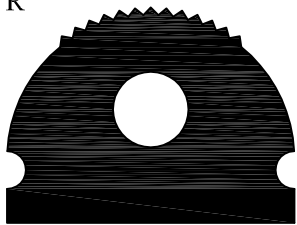

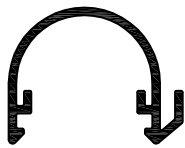
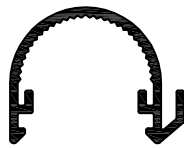
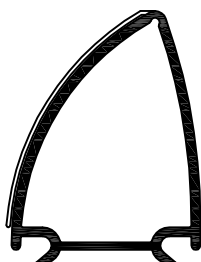
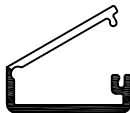
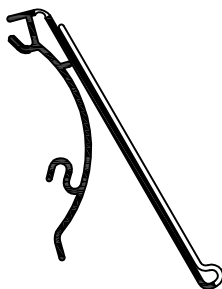
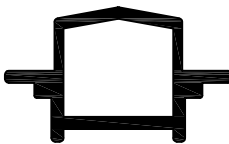
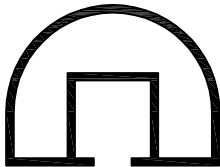

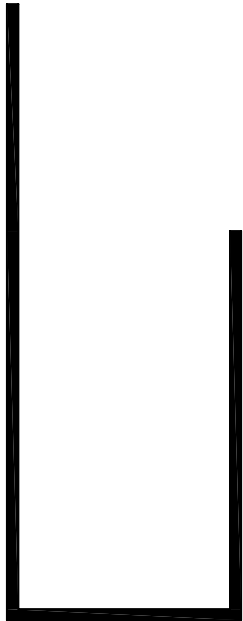



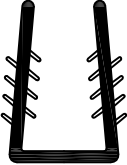

		
Ref. 4980 PC		
		
Ref. 4986 FL		
		
Ref. 4987 RG		
		
Ref. 4988 RG+RG+FL	Ref. 4989 RG	Ref. 4990 RG
		
Ref. 4991 RG	Ref. 4992 RG	Ref. 4993 RG

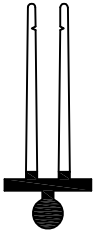
 <p>Ref. 4994 PMMA</p>	 <p>Ref. 4995 PMMA</p>	 <p>Ref. 4996 PMMA</p>
<p>R</p>  <p>Ref. 4997 PMMA</p>	<p>R</p>  <p>Ref. 4998 PU</p>	<p>R</p>  <p>Ref. 4999 PC</p>
 <p>Ref. 5000 RG+RG+FL</p>	<p>R</p>  <p>Ref. 5001 PC</p>	<p>R</p>  <p>Ref. 5002 PC</p>
	<p>R</p>  <p>Ref. 5004 RG +FL</p>	<p>R</p>  <p>Ref. 5005 RG +RG</p>
	<p>R</p>  <p>Ref. 5006 RG+RG+FL</p>	









<p>R</p>  <p>Ref. 5007 FL</p>	<p>R</p>  <p>Ref. 5008 RG+RG+FL</p>	
 <p>Ref. 5009 RG+FL</p>	<p>R</p>  <p>Ref. 5010 PC</p>	
<p>R</p>  <p>Ref. 5011 PC</p>	<p>R</p>  <p>Ref. 5012 PC</p>	<p>R</p>  <p>Ref. 5013 RG + FL</p>
<p>R</p>  <p>Ref. 5014 PUR</p>	<p>R</p>  <p>Ref. 5015 RG + FL</p>	
 <p>Ref. 5016 PMMA</p>	 <p>Ref. 5017 PMMA</p>	 <p>Ref. 5018 FL</p>





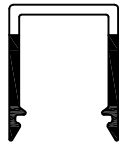

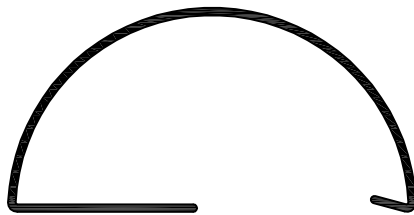

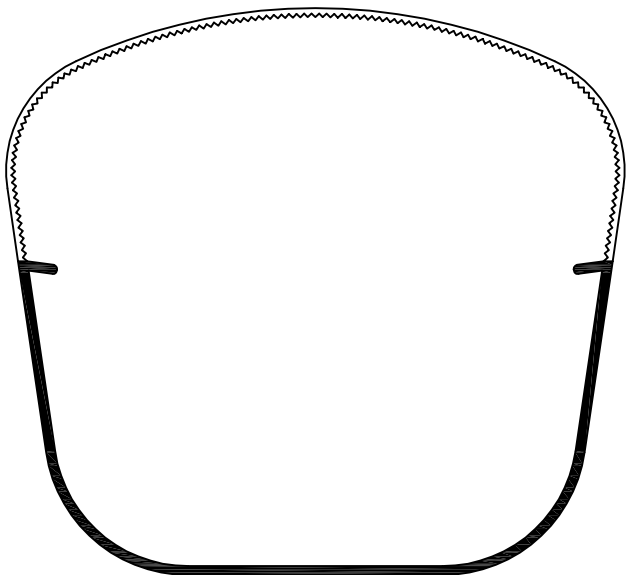
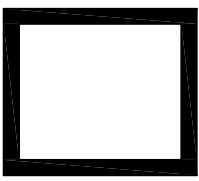

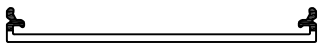
<p>R</p>  <p>Ref. 5019 FL</p>	<p>R</p>  <p>Ref. 5020 RG</p>	<p>R</p>  <p>Ref. 5021 RG + FL</p>
<p>R</p>  <p>Ref. 5022 RG + FL</p>	<p>R</p>  <p>Ref. 5023 PC</p>	<p>R</p>  <p>Ref. 5024 RG + FL</p>
<p>R</p>  <p>Ref. 5025 RG</p>	<p>R</p>  <p>Ref. 5026 RG</p>	<p>R</p>  <p>Ref. 5027 RG + FL</p>
<p>R</p>  <p>Ref. 5028 PC</p>	<p>R</p>  <p>Ref. 5029 RG</p>	
<p>R</p>  <p>Ref. 5030 FL</p>	<p>R</p>  <p>Ref. 5031 PC</p>	<p>R</p>  <p>Ref. 5032 FL</p>





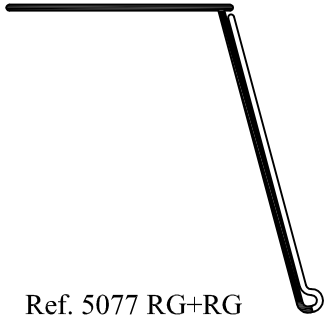

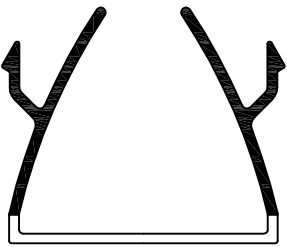
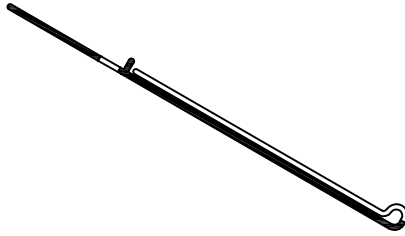
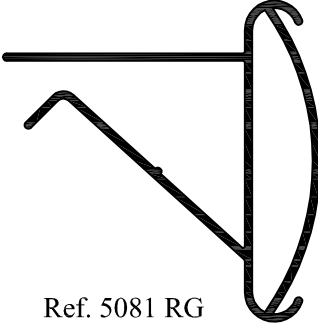
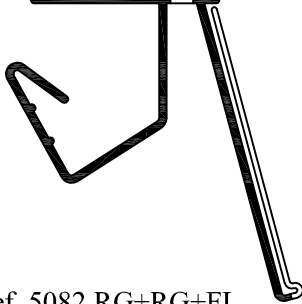

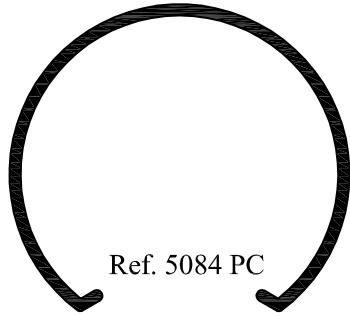

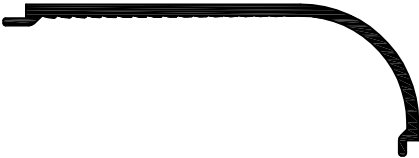
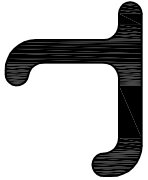
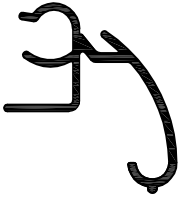
<p>R</p>  <p>Ref. 5033 PMMA</p>	<p>R</p>  <p>Ref. 5034 PMMA</p>	<p>R</p>  <p>Ref. 5035 RG+RG</p>
 <p>Ref. 5036 PC+PC</p>	<p>R</p>  <p>Ref. 5037 RG+RG+FL</p>	 <p>Ref. 5038 RG</p>
<p>R</p>  <p>Ref. 5039 RG</p>	<p>R</p>  <p>Ref. 5040 FL</p>	<p>R</p>  <p>Ref. 5041 FL</p>
<p>R</p>  <p>Ref. 5044 RG</p>	<p>R</p>  <p>Ref. 5042 PMMA</p>	<p>R</p>  <p>Ref. 5043 RG+FL</p>
	<p>R</p>  <p>Ref. 5047 PC + PC</p>	

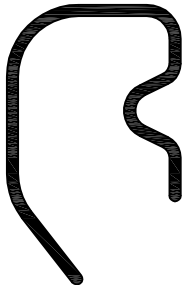

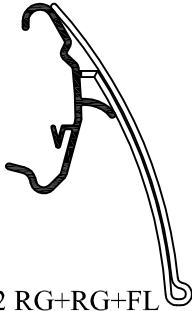



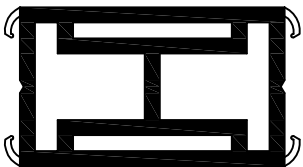



<p>R</p>  <p>Ref. 5046 RG+FL</p>	<p>R</p>  <p>Ref. 5048 PC</p>	
<p>R</p>  <p>Ref. 5049 PC</p>	<p>R</p>  <p>Ref. 5050 RG+FL</p>	<p>R</p>  <p>Ref. 5051 FL</p>
<p>R</p>  <p>Ref. 5052 FL</p>	<p>R</p>  <p>Ref. 5053 PU</p>	
<p>R</p>  <p>Ref. 5054 PC</p>	<p>R</p>  <p>Ref. 5055 PMMA</p>	<p>R</p>  <p>Ref. 5056 PC</p>
<p>R</p>  <p>Ref. 5057 PC+PC</p>	<p>R</p>  <p>Ref. 5058 PC+PC</p>	

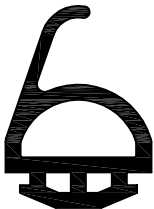

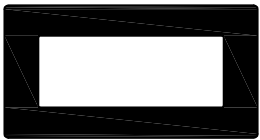

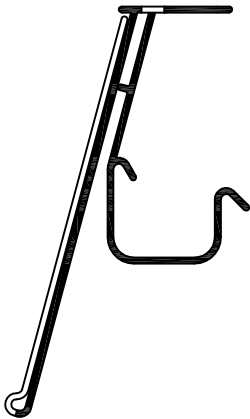







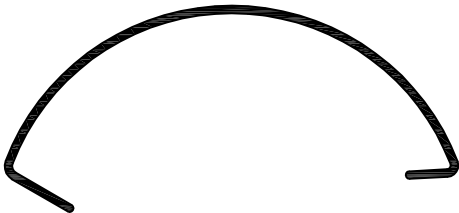
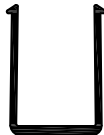

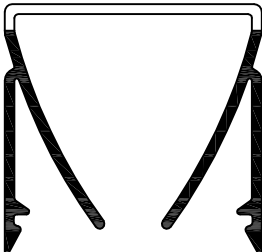

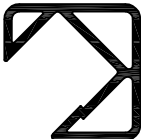
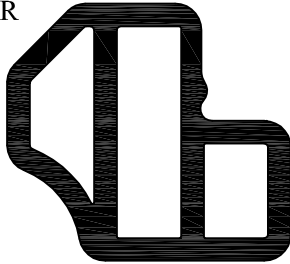
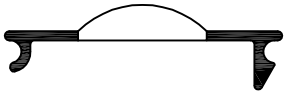

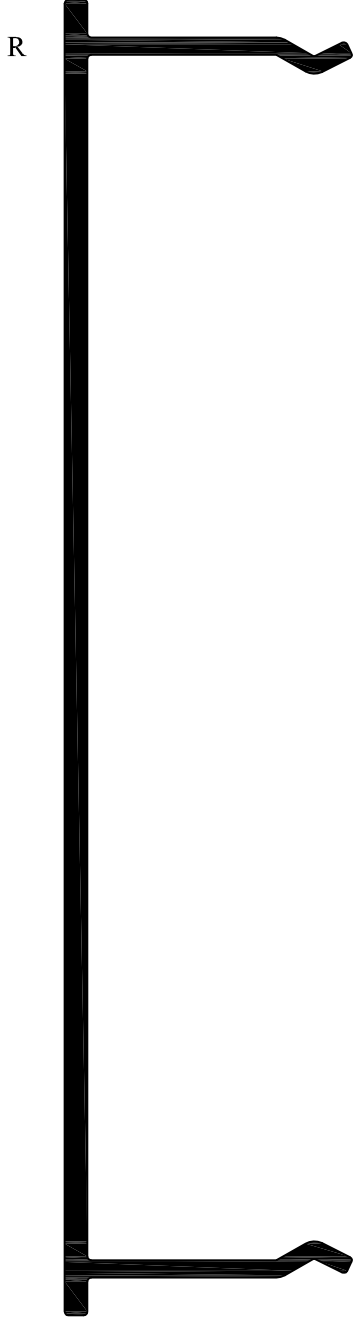

<p>R</p>  <p>Ref. 5059 PC</p>	 <p>Ref. 5060 FL</p>	
<p>R</p>  <p>Ref. 5061 RG+FL</p>	<p>R</p>  <p>Ref. 5062 RG</p>	<p>R</p>  <p>Ref. 5063 PC+PC</p>
<p>R</p>  <p>Ref. 5064 PC</p>	<p>R</p>  <p>Ref. 5065 PC</p>	<p>a</p>  <p>Ref. 5066 RG</p>
 <p>Ref. 5067 PMMA</p>	<p>R</p>  <p>Ref. 5068 PC+PC</p>	
<p>R</p>  <p>Ref. 5069 FL</p>		

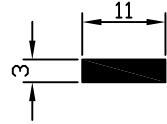
<p>R</p>  <p>Ref. 5070 PC+PC</p>	<p>R</p>  <p>Ref. 5071 PC</p>	<p>R</p>  <p>Ref. 5072 PC</p>
 <p>Ref. 5073 RG+FL</p>	<p>R</p>  <p>Ref. 5074 PC</p>	 <p>Ref. 5075 PC</p>
<p>R</p>  <p>Ref. 5076 PC</p>	 <p>Ref. 5077 RG+RG</p>	<p>R</p>  <p>Ref. 5078 PC</p>
<p>R</p>  <p>Ref. 5079 PC+PC</p>	 <p>Ref. 5080 RG+RG+FL</p>	 <p>Ref. 5081 RG</p>
 <p>Ref. 5082 RG+RG+FL</p>	<p>R</p>  <p>Ref. 5083 RG+RG</p>	 <p>Ref. 5084 PC</p>

<p>R</p>  <p>Ref. 5085 PC</p>	<p>R</p>  <p>Ref. 5086 FL</p>	<p>R</p>  <p>Ref. 5087 RG</p>
<p>R</p>  <p>Ref. 5088 PC</p>	<p>R</p>  <p>Ref. 5089 PP</p>	<p>R</p>  <p>Ref. 5090 FL</p>
<p>R</p>  <p>Ref. 5091 FL</p>	<p>R</p>  <p>Ref. 5092 RG+RG+FL</p>	<p>R</p>  <p>Ref. 5093 PC</p>
<p>R</p>  <p>Ref. 5094 FL</p>	 <p>Ref. 5095 RG+FL</p>	
<p>R</p>  <p>Ref. 5096 RG+FL</p>	<p>R</p>  <p>Ref. 5097 PMMA</p>	<p>R</p>  <p>Ref. 5098 PMMA</p>

<p>R</p>  <p>Ref. 5099 PC</p>	<p>R</p>  <p>Ref. 5100 FL</p>	<p>R</p>  <p>Ref. 5101 PC</p>
<p>R</p>  <p>Ref. 5102 FL</p>	<p>R</p>  <p>Ref. 5103 PC</p>	<p>R</p>  <p>Ref. 5104 FL+FL</p>
<p>R</p>  <p>Ref. 5105 FL</p>	<p>R</p>  <p>Ref. 5106 PC</p>	<p>R</p>  <p>Ref. 5109 RG+RG+FL</p>
<p>R</p>  <p>Ref. 5107 PC</p>	<p>R</p>  <p>Ref. 5108 PMMA</p>	
<p>R</p>  <p>Ref. 5110 RG+FL</p>		<p>R</p>  <p>Ref. 5111 PC</p>

	 Ref. 5113 RG	R  Ref. 5114 RG
 Ref. 5115 RG		R  Ref. 5116 FL
R  Ref. 5117 FL	R  Ref. 5118 PC+PC	 Ref. 5119 FL
R  Ref. 5120 PC	R  Ref. 5121 RG	R  Ref. 5122 FL
R  Ref. 5124 PMMA+PMMA	R  Ref. 5125 RG	R  Ref. 5126 PC

 <p>Ref. 5123 PMMA</p>	<p>R</p>  <p>Ref. 5127 PMMA</p>	<p>R</p>  <p>Ref. 5128 FL</p>
	 <p>Ref. 5129 RG</p>	<p>R</p>  <p>Ref. 5130 PMMA</p>
	<p>R</p>  <p>Ref. 5131 PMMA</p>	
	 <p>Ref. 5134 RG+RG</p>	<p>R</p>  <p>Ref. 5136 RG</p>
<p>R</p>  <p>Ref. 5137 RG</p>	<p>R</p>  <p>Ref. 5138 PC</p>	 <p>Ref. 5139 FL</p>

R

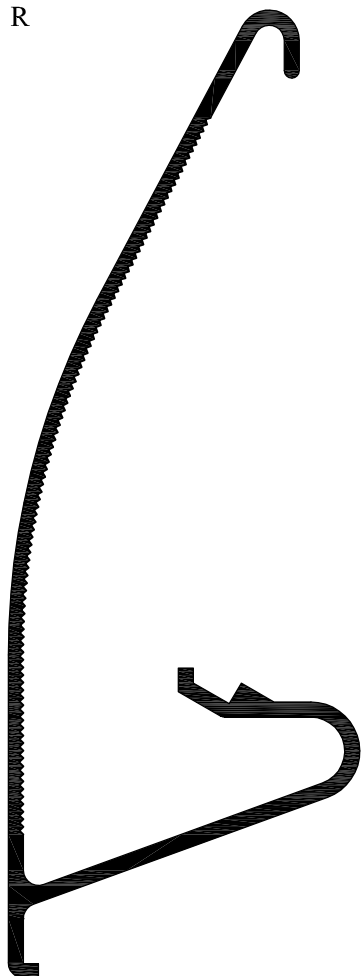

Ref. 5135 PC

R

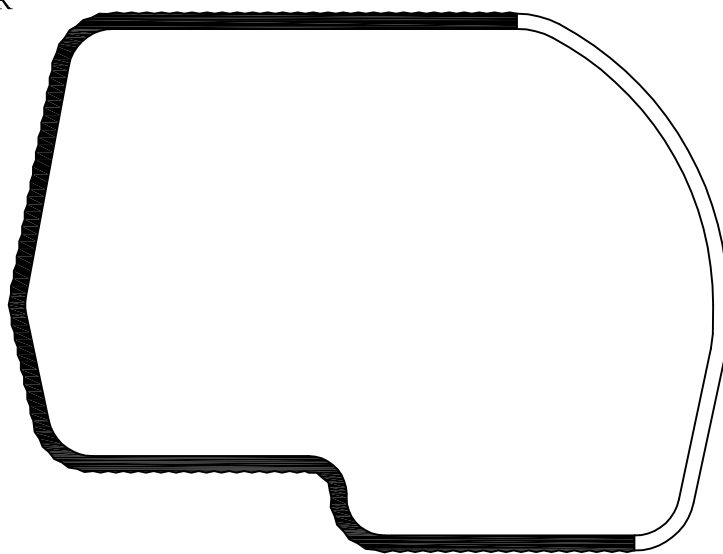

Ref. 5132 PC

R



Ref. 5141 PC

R







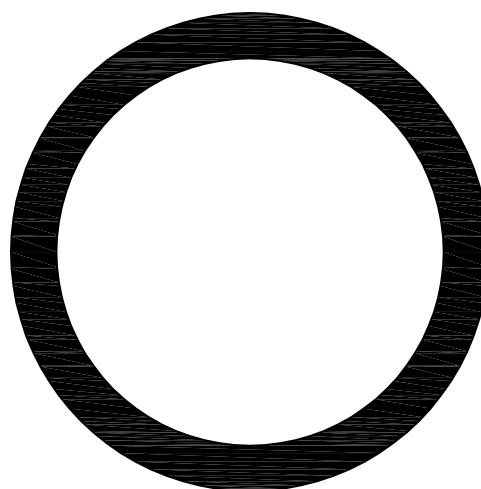

Ref. 5140 PC

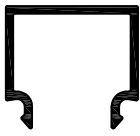



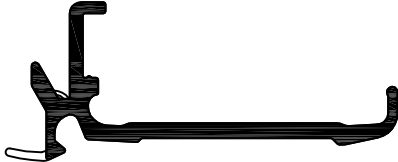
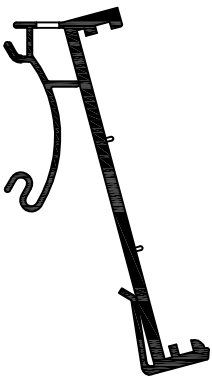
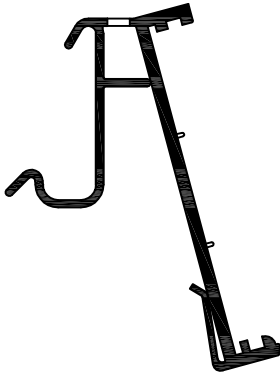
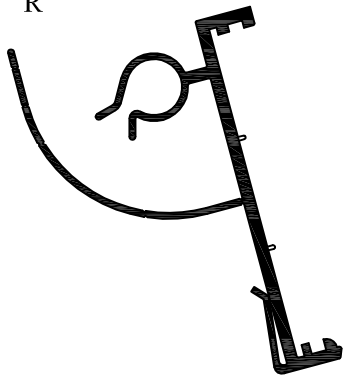
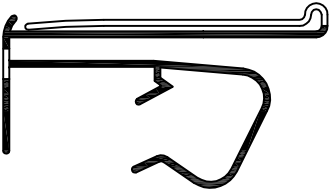

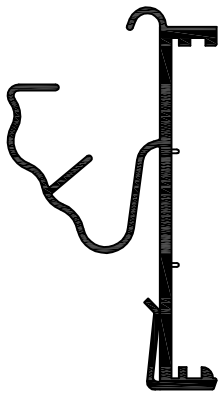

R

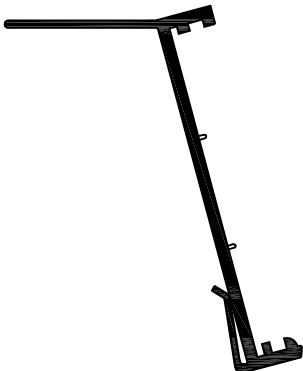
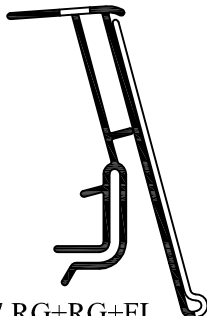

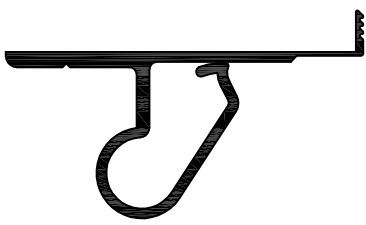



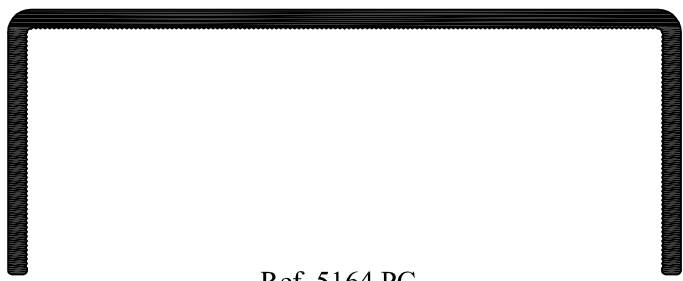





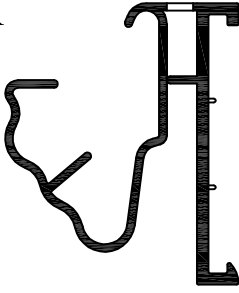
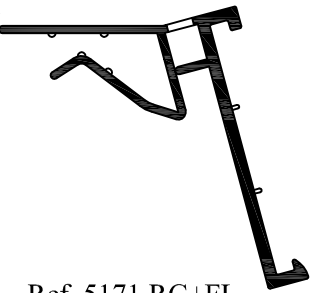



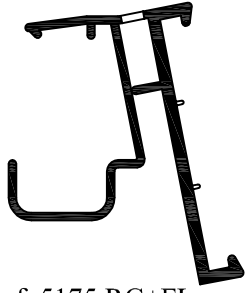
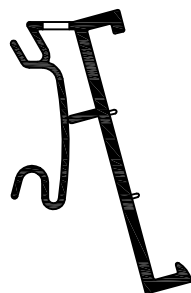
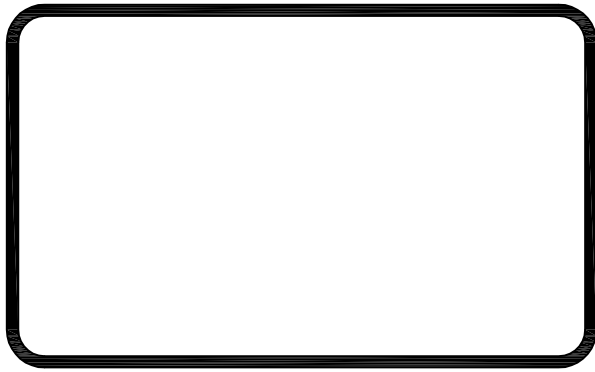

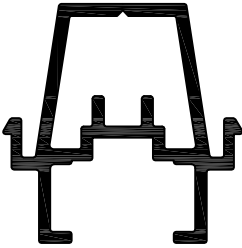

Ref. 5143 RG



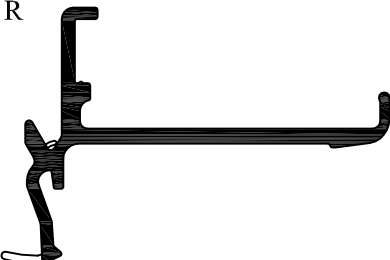
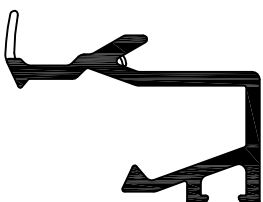

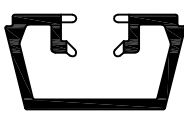

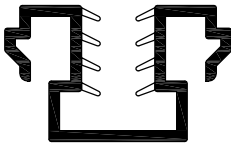
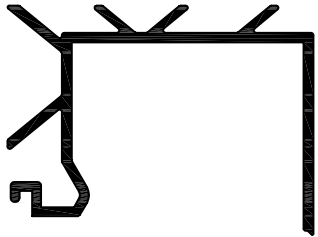
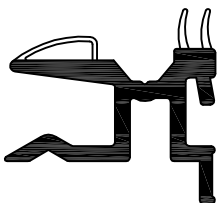



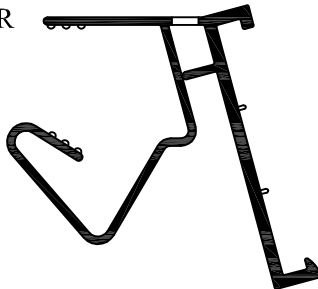

<p>R</p>  <p>Ref. 5144 PMMA</p>	<p>R</p>  <p>Ref. 5145 PC</p>	<p>R</p>  <p>Ref. 5146 PC</p>
 <p>Ref. 5147 PC</p>	<p>R</p>  <p>Ref. 5148 RG</p>	<p>R</p>  <p>Ref. 5149 RG+FL</p>
<p>R</p>  <p>Ref. 5150 RG+FL</p>	<p>R</p>  <p>Ref. 5151 RG+FL</p>	<p>R</p>  <p>Ref. 5152 RG+FL</p>
<p>R</p>  <p>Ref. 5153 RG+RG+FL</p>	<p>R</p>  <p>Ref. 5154 PC</p>	<p>R</p>  <p>Ref. 5155 RG+FL</p>

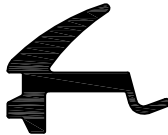









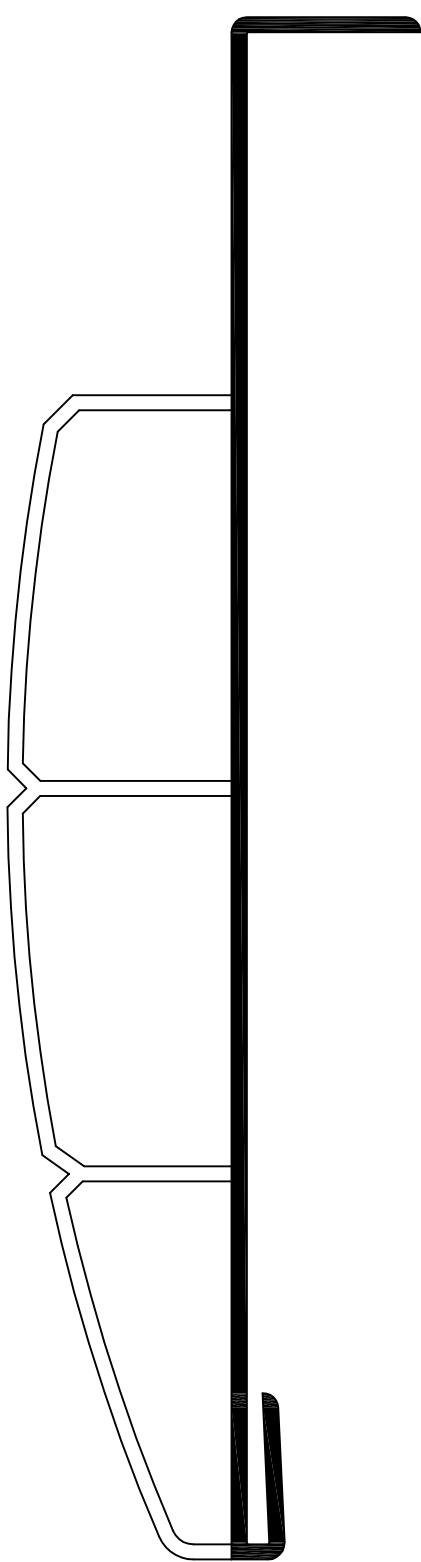
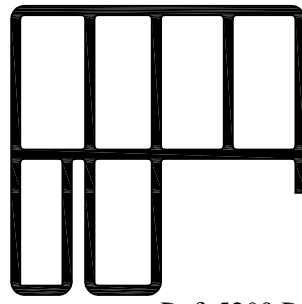
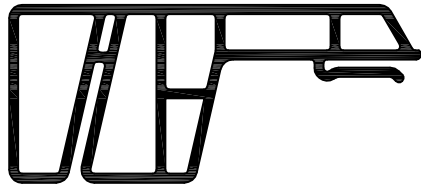
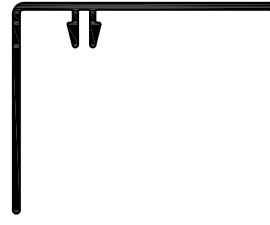



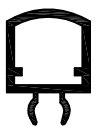

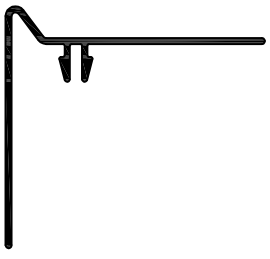

<p>R</p>  <p>Ref. 5156 RG+FL</p>	<p>R</p>  <p>Ref. 5157 RG+RG+FL</p>	<p>R</p>  <p>Ref. 5158 RG+FL</p>
	<p>R</p>  <p>Ref. 5160 RG</p>	<p>R</p>  <p>Ref. 5161 RG</p>
<p>R</p>  <p>Ref. 5159 PC</p>	<p>R</p>  <p>Ref. 5163 RG+RG</p>	
<p>R</p>  <p>Ref. 5162 PC</p>	<p>R</p>  <p>Ref. 5165 PC</p>	
<p>R</p>  <p>Ref. 5164 PC</p>	<p>R</p>  <p>Ref. 5166 PC</p>	

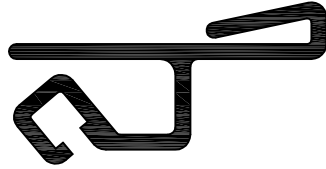





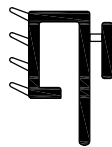
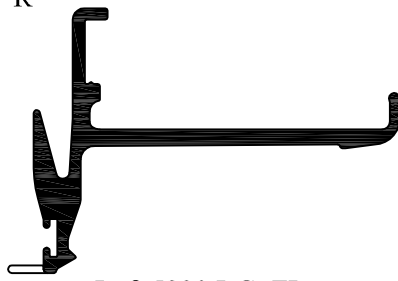
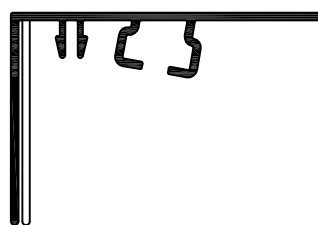

<p>R</p>  <p>Ref. 5167 RG+FL</p>	<p>R</p>  <p>Ref. 5168 PC</p>	<p>R</p>  <p>Ref. 5169 RG+FL</p>
<p>R</p>  <p>Ref. 5170 RG+FL</p>	<p>R</p>  <p>Ref. 5171 RG+FL</p>	<p>R</p>  <p>Ref. 5172 RG+FL</p>
<p>R</p>  <p>Ref. 5173 RG+FL</p>	<p>R</p>  <p>Ref. 5174 RG</p>	<p>R</p>  <p>Ref. 5175 RG+FL</p>
<p>R</p>  <p>Ref. 5176 RG+FL</p>	<p>R</p>  <p>Ref. 5180 RG</p>	
<p>R</p>  <p>Ref. 5177 PC</p>		

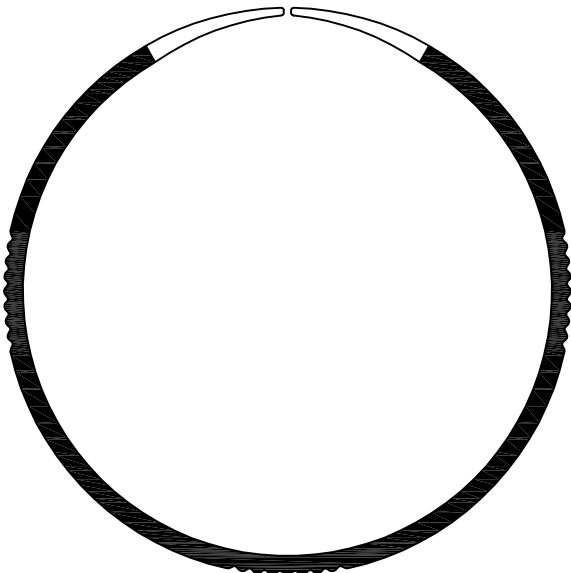

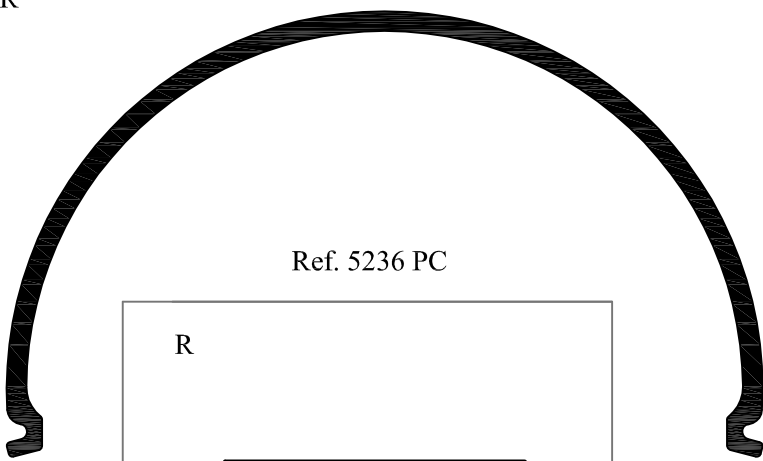
<p>R</p>  <p>Ref. 5178 RG</p>	<p>R</p>  <p>Ref. 5179 RG + FL</p>	 <p>Ref. 5181 FL</p>
<p>R</p>  <p>Ref. 5182 PMMA+PMMA</p>	<p>R</p>  <p>Ref. 5183 PMMA+PMMA</p>	<p>R</p>  <p>Ref. 5184 RG + FL</p>
<p>R</p>  <p>Ref. 5185 RG + FL</p>	 <p>Ref. 5186 FL</p>	 <p>Ref. 5187 PC</p>
<p>R</p>  <p>Ref. 5188 RG + FL</p>	 <p>Ref. 5189 PC</p>	<p>R</p>  <p>Ref. 5190 RG+FL</p>
<p>R</p>  <p>Ref. 5191 RG</p>	<p>R</p>  <p>Ref. 5192 RG+FL</p>	 <p>Ref. 5193 PC</p>

<p>R</p>  <p>Ref. 5194 RG+FL</p>	<p>R</p>  <p>Ref. 5195 RG</p>	<p>R</p>  <p>Ref. 5196 RG+FL</p>
<p>R</p>  <p>Ref. 5197 PC+PC</p>	<p>R</p>  <p>Ref. 5198 FL</p>	<p>R</p>  <p>Ref. 5199 PC</p>
<p>R</p>  <p>Ref. 5200 RG</p>	<p>R</p>  <p>Ref. 5201 RG</p>	<p>R</p>  <p>Ref. 5202 RG</p>
<p>R</p>  <p>Ref. 5203 RG</p>	<p>R</p>  <p>Ref. 5204 RG</p>	<p>R</p>  <p>Ref. 5205 RG+RG+FL</p>
	<p>R</p>  <p>Ref. 5208 RG</p>	

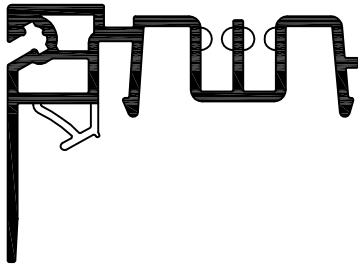
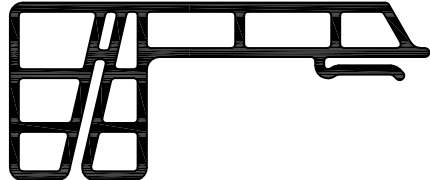



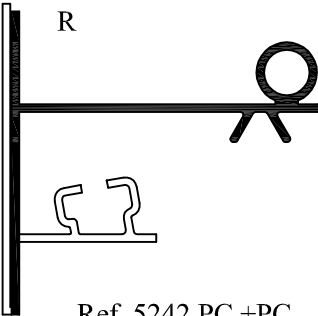
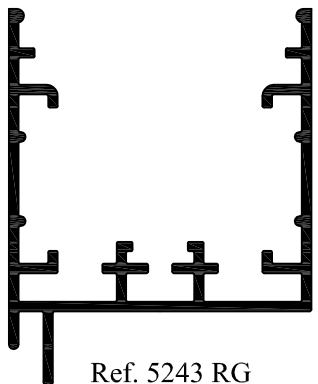
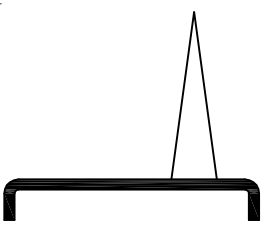
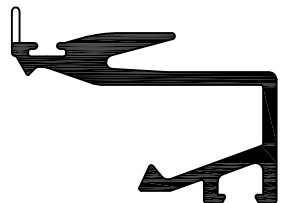

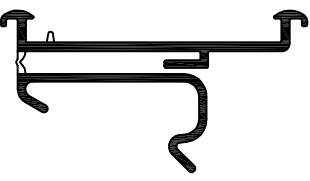
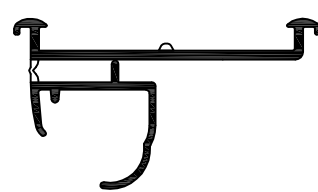
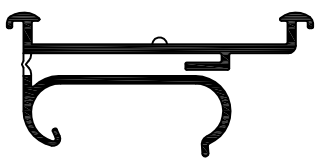
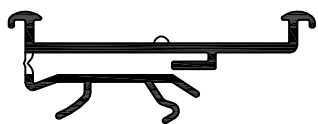
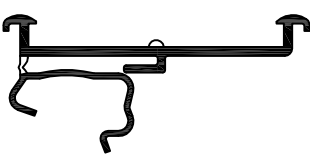

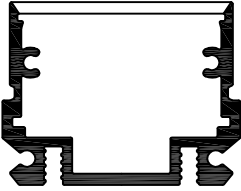

 <p>Ref. 5206 RG+FL</p>	<p>R</p>  <p>Ref. 5209 RG</p>	<p>R <span style="float: right;">a</span></p>  <p>Ref. 5210 RG</p>
	<p>R</p>  <p>Ref. 5211 PC</p>	<p>R</p>  <p>Ref. 5212 PC</p>
	<p>R</p>  <p>Ref. 5213 FL</p>	 <p>Ref. 5214 RG+RG</p>
	<p>R</p>  <p>Ref. 5215 PC</p>	<p>R</p>  <p>Ref. 5216 PC</p>
	<p>R</p>  <p>Ref. 5218 PC</p>	 <p>Ref. 5219 PC</p>

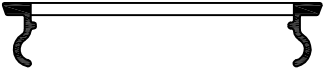

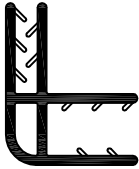

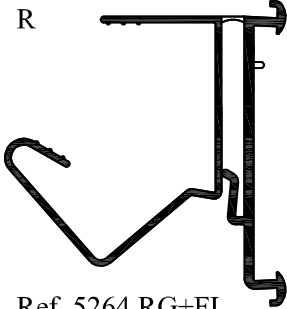
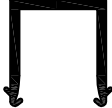



 Ref. 5217 PC		R  Ref. 5220 RG
R  Ref. 5221 PMMA	 Ref. 5222 PC	 Ref. 5223 RG+FL
R  Ref. 5224 PC		 Ref. 5226 RG
R  Ref. 5225 PC		R  Ref. 5228 PC
R  Ref. 5229 RG+FL	R  Ref. 5230 RG+FL	R  Ref. 5231 PC+PC

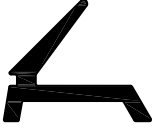





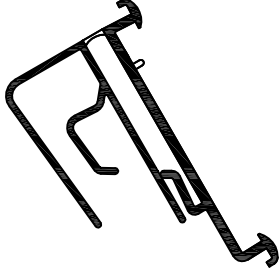
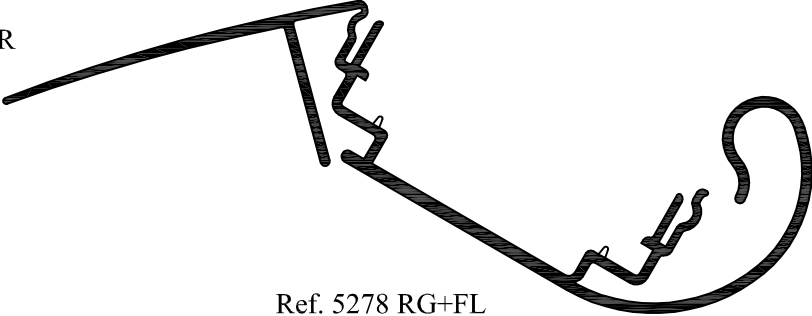

<p>R</p>  <p>Ref. 5227 RG+FL</p>	<p>R</p>  <p>Ref. 5232 PC+PC</p>	
<p>R</p>  <p>Ref. 5236 PC</p> <div data-bbox="295 1400 790 1747" style="border: 1px solid black; padding: 5px; margin: 10px auto; width: fit-content;"> <p>R</p>  <p>Ref. 5235 PC</p> </div>	<p>R</p>  <p>Ref. 5233 FL</p>	
<p>R</p>  <p>Ref. 5238 PC</p>	<p>R</p>  <p>Ref. 5239 RG</p>	<p>R</p>  <p>Ref. 5234 RG+FL</p>
<p>R</p>  <p>Ref. 5237 RG</p>	<p>R</p>  <p>Ref. 5240 PC</p>	

<p>R</p>  <p>Ref. 5241 RG</p>	<p>R</p>  <p>Ref. 5242 PC +PC</p>	<p>R</p>  <p>Ref. 5243 RG</p>
<p>R</p>  <p>Ref. 5244 RG+FL</p>	<p>R</p>  <p>Ref. 5246 RG+FL</p>	 <p>Ref. 5245 PC</p>
 <p>Ref. 5248 RG+FL</p>	<p>R</p>  <p>Ref. 5249 RG+FL</p>	
<p>R</p>  <p>Ref. 5250 RG+FL</p>	<p>R</p>  <p>Ref. 5251 RG+FL</p>	<p>R</p>  <p>Ref. 5252 RG+FL</p>

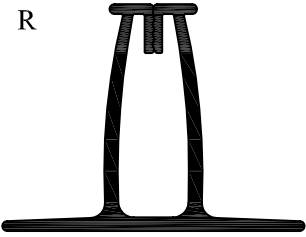
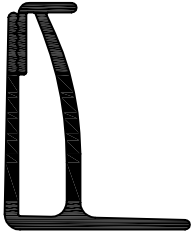
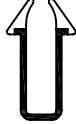

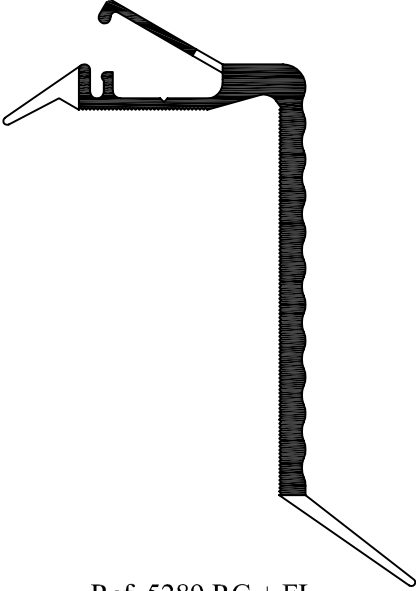
<p>R</p>  <p>Ref. 5253 RG+RG</p>	<p>R</p>  <p>Ref. 5255 PMMA+PMMA</p>	<p>R</p>  <p>Ref. 5256 PMMA+PMMA</p>
<p>R</p>  <p>Ref. 5257 PC + PC</p>	<p>R</p>  <p>Ref. 5258 FL</p>	<p>R</p>  <p>Ref. 5259 FL</p>
 <p>Ref. 5260 RG+FL</p>	<p>R</p>  <p>Ref. 5261 PC</p>	 <p>Ref. 5262 FL</p>
	<p>R</p>  <p>Ref. 5264 RG+FL</p>	<p>R</p>  <p>Ref. 5265 RG</p>
<p>R</p>  <p>Ref. 5266 RG</p>	<p>R</p>  <p>Ref. 5267 RG</p>	 <p>Ref. 5268 FL</p>

 <p>Ref. 5269 FL</p>	<p>R</p>  <p>Ref. 5270 RG</p>	<p>R</p>  <p>Ref. 5271 RG</p>
<p>R</p>  <p>Ref. 5272 RG</p>	<p>R</p>  <p>Ref. 5273 PC</p>	<p>R</p>  <p>Ref. 5274 FL</p>
<p>R</p>  <p>Ref. 5276 RG+FL</p>	<p>R</p>  <p>Ref. 5277 RG+FL</p>	
<p>R</p>  <p>Ref. 5278 RG+FL</p>		
<p>R</p>  <p>Ref. 5280 FL</p>		

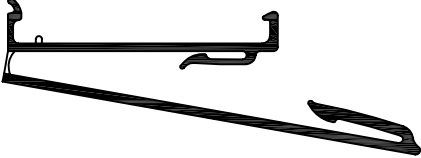
<p>R</p>  <p>Ref. 5283 PC</p>	<p>R</p>  <p>Ref. 5284 PC</p>	<p>R</p>  <p>Ref. 5285 RG</p>
<p>R</p>  <p>Ref. 5286 RG</p>	<p>R</p>  <p>Ref. 5287 RG</p>	<p>R</p>  <p>Ref. 5288 RG+FL</p>
<p>R</p>  <p>Ref. 5290 FL</p>	<p>R</p>  <p>Ref. 5289 RG + FL</p>	<p>R</p>  <p>Ref. 5291 FL</p>
<p>R</p>  <p>Ref. 5292 RG + FL</p>		<p>R</p>  <p>Ref. 5293 PC</p>
	<p>R</p>  <p>Ref. 5295 RG + FL</p>	

R



Ref. 5296 RG

R

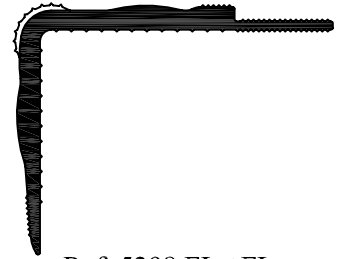

Ref. 5298 FL +FL

R

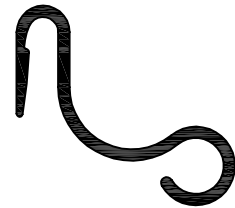

Ref. 5300 RG

R



Ref. 5301 RG+FL

R

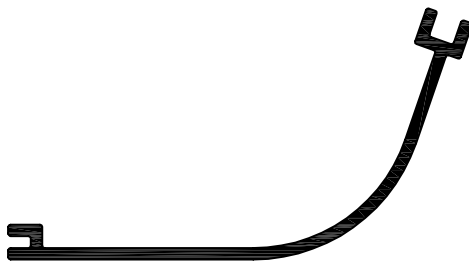









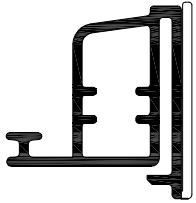

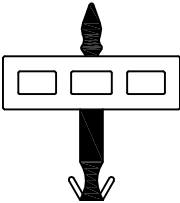
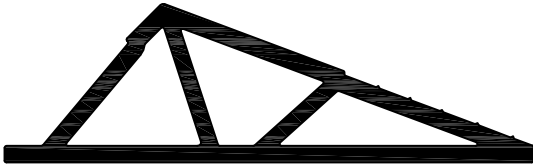

Ref. 5303 PC

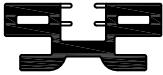



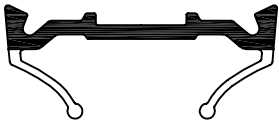
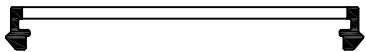



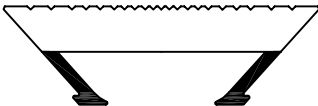



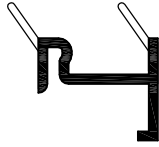

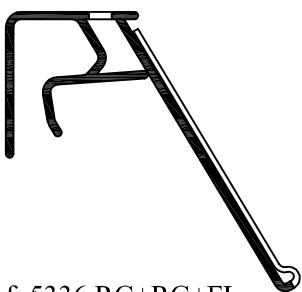
R

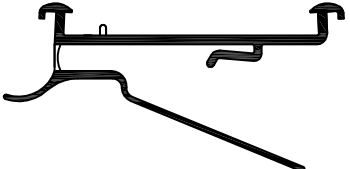

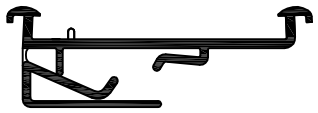

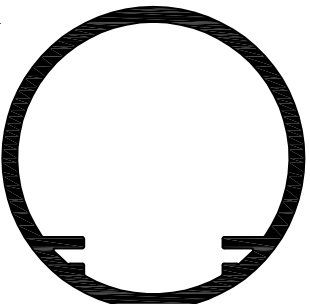





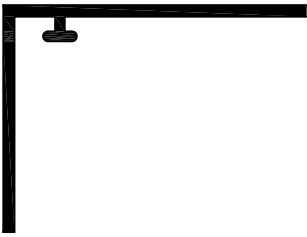

Ref. 5304 RG

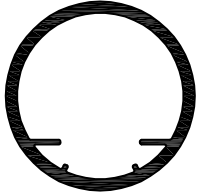
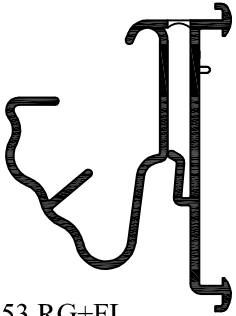
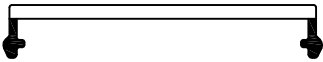





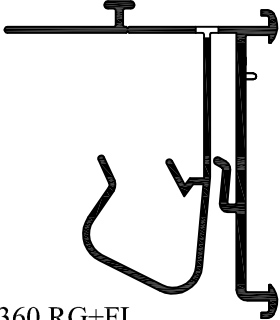
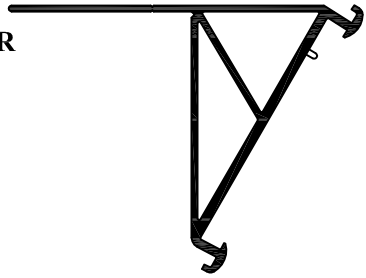

	<p>R</p>  <p>Ref. 5307 PC + PC</p>	<p>R</p>  <p>Ref. 5308 RG</p>
	<p>R</p>  <p>Ref. 5310 RG</p>	
<p>R</p>  <p>Ref. 5309 RG + FL</p>	<p>R</p>  <p>Ref. 5312 FL</p>	
<p>R</p>  <p>Ref. 5311 RG</p>	<p>R</p>  <p>Ref. 5313 FL</p>	<p>R</p>  <p>Ref. 5314 FL</p>
	<p>R</p>  <p>Ref. 5316 RG+FL</p>	

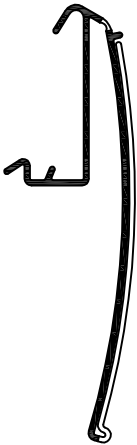



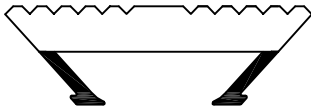

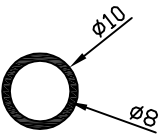

<p>R</p>  <p>Ref. 5318 PP+CA</p>	<p>R</p>  <p>Ref. 5319 RG+FL</p>	
<p>R</p>  <p>Ref. 5320 RG+FL</p>		
	<p>R</p>  <p>Ref. 5324 PC+PC</p>	<p>R</p>  <p>Ref. 5325 RG+RG</p>
		<p>R</p>  <p>Ref. 5328 PC</p>
	<p>R</p>  <p>Ref. 5330 RG</p>	<p>R</p>  <p>Ref. 5331 PMMA+PMMA</p>



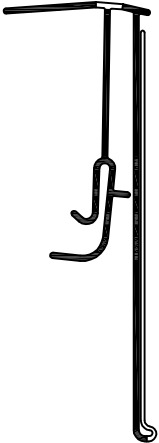
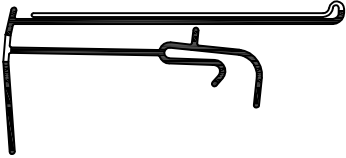

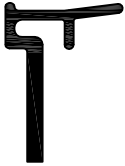
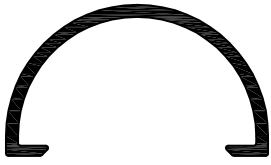

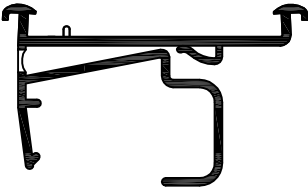



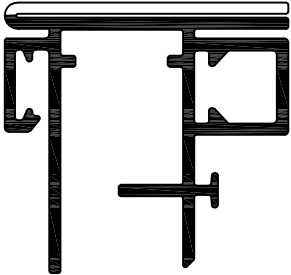

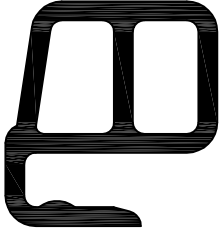
<p>R</p>  <p>Ref. 5332 RG+RG</p>	<p>R</p>  <p>Ref. 5333 PC</p>	<p>R</p>  <p>Ref. 5334 RG+FL</p>
<p>R</p>  <p>Ref. 5335 PP+CA</p>	<p>R</p>  <p>Ref. 5336 RG+RG+FL</p>	<p>R</p>  <p>Ref. 5337 PC</p>
<p>R</p>  <p>Ref. 5338 RG+FL</p>	<p>R</p>  <p>Ref. 5339 PP+CA</p>	<p>R</p>  <p>Ref. 5340 RG+FL</p>
<p>R</p>  <p>Ref. 5341 RG+FL</p>	<p>R</p>  <p>Ref. 5345 PMMA</p>	<p>R</p>  <p>Ref. 5343 PC</p>
<p>R</p>  <p>Ref. 5344 RG</p>	<p>R</p>  <p>Ref. 5346 RG</p>	

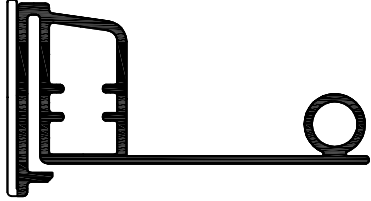





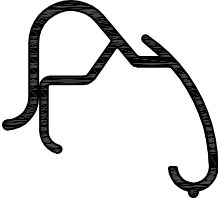
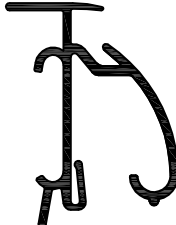



<p>R</p>  <p>Ref. 5347 RG+ RG</p>	<p>R</p>  <p>Ref. 5348 RG+RG</p>	<p>R</p>  <p>Ref. 5349 RG</p>
 <p>Ref. 5350 RG</p>	<p>R</p>  <p>Ref. 5351 PC+PC</p>	<p>R</p>  <p>Ref. 5352 PMMA</p>
<p>R</p>  <p>Ref. 5353 RG+FL</p>	<p>R</p>  <p>Ref. 5354 PC+PC</p>	<p>R</p>  <p>Ref. 5355 PMMA</p>
<p>R</p>  <p>Ref. 5356 RG</p>	<p>R</p>  <p>Ref. 5357 PP+CA</p>	<p>R</p>  <p>Ref. 5358 PC</p>
<p>R</p>  <p>Ref. 5359 PC</p>	<p>R</p>  <p>Ref. 5360 RG+FL</p>	<p>R</p>  <p>Ref. 5361 RG+FL</p>

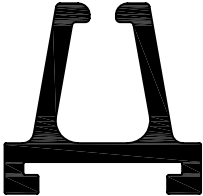

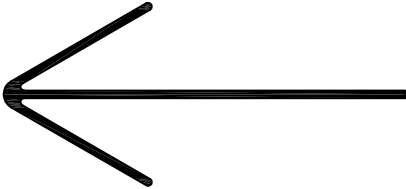
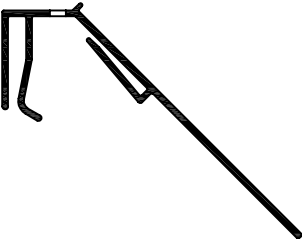
<p>R</p>  <p>Ref. 5364 RG+RG+FL</p>	 <p>Ref. 5362 EPDM</p>	 <p>Ref. 5363 RG+RG</p>
<p>R</p>  <p>Ref. 5367 PC</p>	<p>R</p>  <p>Ref. 5368 PC</p>	<p>R</p>  <p>Ref. 5366 PMMA+PMMA</p>
<p>R</p>  <p>Ref. 5369 PC</p>		
 <p>Ref. 5370 RG</p>	<p>R</p>  <p>Ref. 5371 RG</p>	<p>R</p>  <p>Ref. 5372 RG</p>

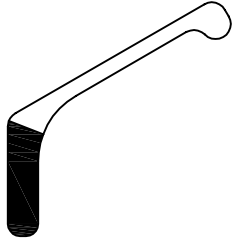
<p>R</p>  <p>Ref. 5373 PC</p>	 <p>Ref. 5374 EPDM</p>	
<p>R</p>  <p>Ref. 5376 RG+RG+FL</p>	<p>R</p>  <p>Ref. 5375 RG+RG+FL</p>	<p>R</p>  <p>Ref. 5377 RG</p>
<p>R</p>  <p>Ref. 5380 RG+FL</p>	<p>R</p>  <p>Ref. 5381 RG</p>	<p>R</p>  <p>Ref. 5382 PC</p>
<p>R</p>  <p>Ref. 5383 RG</p>	<p>R</p>  <p>Ref. 5384 RG+FL</p>	<p>R</p>  <p>Ref. 5385 RG+RG+FL</p>

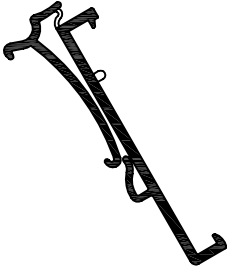
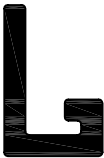
<p>R</p>  <p>Ref. 5386 PC+PC</p>	<p>R</p>  <p>Ref. 5387 PC</p>	<p>R</p>  <p>Ref. 5388 PMMA</p>
<p>R</p>  <p>Ref. 5389 FL</p>	<p>R</p>  <p>Ref. 5390 PC</p>	<p>R</p>  <p>Ref. 5391 PC+PC</p>
 <p>Ref. 5392 RG+FL</p>	<p>R</p>  <p>Ref. 5393 PC</p>	
<p>R</p>  <p>Ref. 5394 RG+FL</p>	<p>R</p>  <p>Ref. 5395 RG</p>	<p>R</p>  <p>Ref. 5396 PP</p>
<p>R</p>  <p>Ref. 5397 RG</p>	<p>R</p>  <p>Ref. 5398 RG</p>	<p>R</p>  <p>Ref. 5399 RG+CA</p>

<p>R</p>  <p>Ref. 5400 PC</p>	<p>R</p>  <p>Ref. 5401 PC</p>	<p>R</p>  <p>Ref. 5402 RG</p>
<p>R</p>  <p>Ref. 5403 FL</p>	<p>R</p>  <p>Ref. 5404 FL</p>	<p>R</p>  <p>Ref. 5405 FL</p>
<p>R</p>  <p>Ref. 5406 RG+FL</p>	<p>R</p>  <p>Ref. 5407 RG</p>	<p>R</p>  <p>Ref. 5408 RG+FL</p>
<p>R</p>  <p>Ref. 5409 FL</p>		<p>R</p>  <p>Ref. 5410 RG+FL</p>
<p>R</p>  <p>Ref. 5411 RG</p>	<p>R</p>  <p>Ref. 5412 RG</p>	<p>R</p>  <p>Ref. 5413 FL</p>



PERFILES DEL VALLÉS S.A.  
Ctra. Sabadell a Granollers, Km. 6,3  
Apartado de Correos, 55  
08184 Palau-solità i Plegamans (BCN)  
Tel. : (34) 938 648 951